

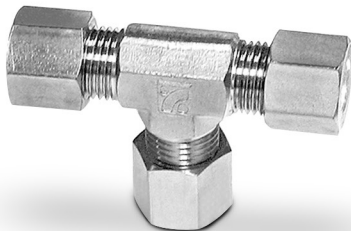

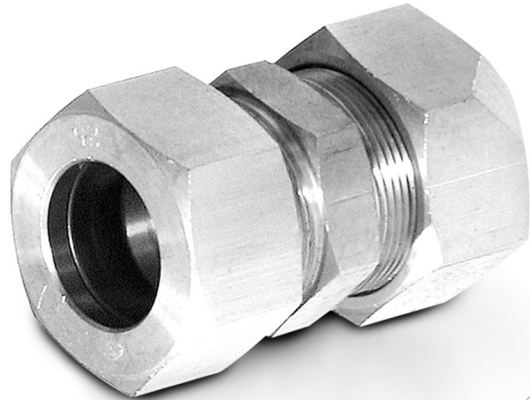





























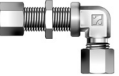





















SUPERLOK DIN Tube Fitting (DIN2353 Bite-type)



SUPERLOK DIN Tube Fitting Index

Tube to Tube			Tube to Tube Port (Adjustable Fittings)			Weld Fittings		
	DU Union	12P		DAE Adjustable Elbow	28P		DWC Welding Connector	43P
	DUE Union Elbow	13P		DABT Adjustable Branch Tee	28P		DAWC Welding Connector with DWN	43P
	DRU Reducing Union	14P		DART Adjustable Run Tee	29P		DWN Welding Nipple	44P
	DUT Union Tee	15P		DSE Swivel Adjustable Elbow	29P		DRWN Reducing Welding	44P
	DUC Union Cross	15P		DSBT Swivel Adjustable Branch Tee	30P	Male & Female Adaptors		
	DRUT Reducing Union Tee	16P		DSRT Swivel Adjustable Run Tee	30P		DMFC Male Female Connector	45P
	DBHU Bulkhead Union	17P		DRD Reducer	31P		DMFG Male Female Gauge Connector	45P
	DBUW Welded Bulkhead Union	17P		DSRAP Swivel Reducing Adaptor	33P		DMFC-ED Male Female Connector with ED-Ring	46P
	DBUE Bulkhead Union Elbow	18P	Tube Port to Female Port				DMFG-ED Male Female Gauge Connector with ED-Ring	46P
Tube to Female Port				DAP-GED/MED Adaptor	35P	Plugs & Caps		
	DCM-UO/MO Male Connector with O-Ring	19P		DSAP-GED/MED Swivel Adaptor	36P		DC Tube Cap	47P
	DCM-GM Male Connector	20P	Tube Port to Tube Port				DP Plug	47P
	DCM-R Male Connector	21P		DSL Swivel Union	37P		DBP-GED/MED Blanking Plugs for Port with ED-Ring	48P
	DCM-M Male Connector	22P	Banjo Fittings				DBP-M Blanking Plugs with O-Ring	48P
	DCM-MK Male Connector	22P		DBE-G/M Banjo Elbow	38P	Spare Part		
	DCM-GED Male Connector with ED-Ring	23P		DHBE-G/M High Pressure Banjo Elbow	39P		DNT Nut	49P
	DCM-MED Male Connector with ED-Ring	24P		DHBT-G/M High Pressure Banjo Tee	40P		DCR Cutting Ring	49P
	DCM-N Male Connector	25P	Gauge Connector & Test Couplings				DED ED-Ring	49P
	DME-R/MK Male Elbow	26P		DFGC-G Pressure Gauge Connector	41P		DOR O-Ring	49P
Tube to Male Thread				DSGC-G Pressure Gauge Swivel Connector	41P			
	DCF-G/M Female Connector	27P		DGAP-G Gauge Adaptor	41P			
				DTPC Tee Test Point Connector	42P			
				DTC Test Coupling	42P			

Introduction

SUPERLOK DIN Tube Fitting

The SUPERLOK DIN type fitting is a flareless metric fitting that consists of a body, a compression ring (Cutting Ring) and a nut. On assembly, two cutting edges of the compression ring “bite” into the outer surface of the tube ensuring the necessary holding power for high pressure.

SUPERLOK DIN Tube Fittings and accessories are designed and manufactured in accordance with DIN2353.

The fittings and components listed in this catalog are intended solely for the assembly of connections for fluid applications.

Design and Construction

The three components of SUPERLOK DIN Tube Fittings are designed and manufactured to ensure strong, reliable, leak-free joint upon proper assembly.

SUPERLOK DIN-type Body

SUPERLOK DIN Tube Fitting bodies are available in over thirty configurations. The shaped products (i. e., elbows, tees, crosses) are forged, then machined to the stringent SUPERLOK fitting specifications.

The forging process further improves the strength and mechanical properties of the fitting material.

Straight products are made from cold-drawn bar stock. The cold drawing operation ensures consistently tight dimensional tolerances, as well as significantly improved strength.

SUPERLOK DIN-type Compression Ring

SUPERLOK DIN Type compression rings are precision machined with all dimensions and surfaces, particularly the critical bite edges, monitored on an ongoing basis. The rings are then heat treated in a manner that provides the hardness, strength, and toughness necessary to satisfy the demanding service conditions that exist in industry today.

SUPERLOK DIN-type Nut

SUPERLOK DIN Type nuts are either cold-formed or machined from cold-drawn material. The cold-forming and cold-drawing operations provide a more tightly packed grain structure, thus improving the material’s strength. In addition, cold-forming significantly improves the fatigue properties or endurance limits of the nuts.

Function of DIN Type Tube Fittings

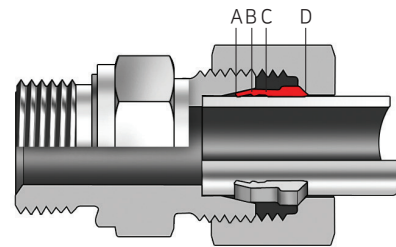

Before Tightening the nut

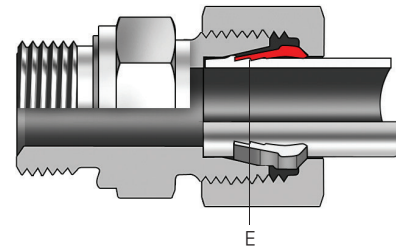

After Tightning the nut

The SUPERLOK DIN Tube Fitting produces a low to high pressure, leak free connection of tubes and components in fluid systems. The basic function of the compression ring is the controlled compression bite of the ring into the tube due to a unique internal geometry.

The front cutting edge (A) has already started cutting into the tube before the second cutting edge (B) starts. As soon as both cutting edges have cut the tube to the designed depth further advance is limited by the stop edge (C).

Owing to the design of both cutting edges and stop edge all forces arising are equally distributed. This distribution along with the specially designed interior collar (D) of the ring guarantees increased safety, particularly with regard to vibration and flexure stresses. The design and function of the compression ring ensure that service vibration loading is not present in the areas of the tubing where the bite is made.

The stop edge causes a sharp increase in tightening forces which is clearly perceptible. After assembly, a visible collar (E) of cut tube material must completely fill the space in front of the first cutting edge. With stainless steel tube and hose connection made from free cutting steel, the collar is less due to the harder material.

During assembly, it is absolutely essential that the tube is held firmly against the stop in the inner cone of the fitting; if not, the cutting process will not take place satisfactorily. Reassembly can be performed unlimited number of times.

Standard Material Specifications

Material Standards

Fitting Body Material	Standards
Carbon Steel	DIN 3859
Brass	DIN 17660 / DIN 17672
Stainless Steel	DIN 17440 (Material No. : 1.4571 & 1.4401)

Pressure and Temperature Load Capability

Working Pressure

Series	Pressure Ratings			
	Steel (DIN3859)		SS316 (DIN 17440)	
	Size	Pressure (bar)	Size	Pressure (bar)
LL (Very light)	4 - 8	100	4 - 8	100
	6 - 18	315	6 - 15	250
L (Light)	-	-	18 - 22	160
	22 - 42	160	28 - 42	100
S (Heavy)	6 - 14	630	6 - 14	630
	16 - 30	400	16 - 25	400
	38	315	30 - 38	315

* Working pressure - The nominal pressure (PN) as referred to in DIN2401, part 1

Permissible operating temperature range

For fitting materials

Material of Fittings	Temperature Ratings
316 Stainless steel	- 60°C up to 400°C (DIN17440)
Carbon Steel	- 40°C up to 120°C (DIN 3859)
Brass	- 60°C up to 175°C

* The specification in the pressure reductions section are to be observed here.

For sealing materials

Seal Material	Temperature Ratings
NBR *	- 35°C up to 100°C
FPM	- 25°C up to 200°C
PTFE	- 60°C up to 240°C

* NBR is standard material for ED-ring and O-ring.



CAUTION

When combining the different fitting and sealing materials the lowest temperature limit in each case is applicable

Pressure Reductions

Recommended pressure reductions (determined by the fluid medium) for higher service temperature

Material of Fittings	Temperature Rating	Reduction of Pressure
316 Stainless steel	- 60°C up to 20°C	-
	50°C	4%
	100°C	11%
	200°C	20%
	300°C	29%
Carbon steel	400°C	33%
	- 40°C up to 120°C	-
Brass	- 60°C up to 175°C	30%

* For different material of tubes and fitting.

The tubes must be tested separately concerning the allowed temperature range and the necessary reduction of pressure.

Gaskets

The gaskets used on valves and fittings are normally manufactured in NBR. All have a working temperature of -35°C to 135°C with a hardness of 85 ± 5 shores.

For higher temperatures Viton seals are suggested with working temperatures between -25°C to 200°C with a hardness of 80 ± 5 shores. All the items that are assembled with gaskets or seals of any kind must be handled according to the DIN 7716 (requisites for the stocking of rubber product).

Seal on thread ends

To obtain the maximum performance, the taper male thread is to be matched with the taper female thread. The cylindrical male thread is to be matched with the cylindrical female thread. It is possible to match a taper male thread with a cylindrical female thread, but this combination is technically valid only in pipings where medium / low performances are required and is never to be used where high pressures are applied.

In case of matching of a cylindrical thread with relatively soft material, it is advisable to use plain gasket type of seal.

Tubing Guide

Allowed Carbon Steel Tubes

- For steel tubes in mild carbon steel we advise to use calibrated seamless cold-drawn without welding tubes ST 37.4 as per DIN 1630.

- Maximum allowed hardness on the outside diameter of the tube is 75 HRB.

- The indicated pressure are to be intended at a constant pressure rate and with temperatures between -20°C and +120°C.

Tube O.D (mm)	Tolerance (mm)	Wall Thickness (mm)	Tube I.D (mm)	Design Pressure (bar)		Weight (kg/m)
				DIN2413 I Static	DIN2413 III Dynamic	
4	0.1	0.5	0.5	313	274	0.047
		0.75	0.75	4.9	391	0.060
		1.0	1.0	522	502	0.074
5	0.1	1.0	3	432	416	0.099
6	0.1	*0.75	4.5	333	289	0.103
		1.0	4	389	372	0.123
		1.5	3	549	526	0.166
		2.0	2	692	662	0.197
		2.25	5	757	725	0.208
8	0.1	1.0	6	333	288	0.173
		1.5	5	431	412	0.240
		2.0	4	549	526	0.296
		2.5	3	658	630	0.339
10	0.1	1.0	8	235	209	0.271
		1.5	7	373	357	0.314
		2.0	6	478	458	0.395
		2.5	5	576	551	0.462
		3.0	4	666	638	0.518
12	0.08	1.0	10	235	209	0.271
		1.5	9	353	303	0.389
		2.0	8	409	391	0.493
		2.5	7	495	474	0.586
		3.0	6	576	551	0.606
14	0.08	3.5	5	651	624	0.734
		* 1	12	201	182	0.321
		1.5	11	302	625	0.462
		2.0	10	403	343	0.592
		2.5	9	434	417	0.709
15	0.08	3.0	8	507	487	0.814
		3.5	7	576	553	0.906
		4	6	576	553	0.986
		* 1.0	13	188	171	0.345
		1.5	12	282	248	0.499
16	0.08	2.0	11	336	321	0.641
		2.5	10	409	391	0.771
		3.0	9	478	458	0.888
		* 1.0	14	176	160	0.370
		1.5	13	264	234	0.536
18	0.08	2.0	12	353	303	0.691
		2.5	11	386	370	0.832
		3.0	10	452	433	0.962
		* 1.0	16	157	143	0.419
		1.5	15	235	209	0.610

Tube O.D (mm)	Tolerance (mm)	Wall Thickness (mm)	Tube I.D (mm)	Design Pressure (bar)		Weight (kg/m)
				DIN2413 I Static	DIN2413 III Dynamic	
20	0.08	* 1.5	17	212	191	0.684
		2.0	16	282	249	0.888
		2.5	15	353	303	1.080
		3.0	14	373	357	1.260
		3.5	13	426	408	1.424
22	0.08	4.0	12	478	458	1.578
		1.5	19	192	174	0.758
		2.0	18	256	227	0.986
		2.5	17	320	278	1.202
		3.0	16	343	328	1.406
25	0.08	2.0	21	226	201	1.134
		2.5	20	282	248	1.387
		3.0	19	338	292	1.628
		4.0	17	394	378	2.072
		4.5	16	437	418	2.275
28	0.08	5.0	15	478	458	2.466
		1.5	25	151	139	0.980
		2.0	24	201	181	1.282
		2.5	23	252	223	1.572
		3.0	22	302	264	1.850
30	0.08	4.0	20	357	342	2.368
		5.0	18	434	415	2.836
		* 2.0	26	188	171	1.381
		2.5	25	235	210	1.695
		3.0	24	282	248	2.000
35	0.15	4.0	22	336	321	2.570
		5.0	20	409	391	3.080
		2.0	31	161	147	1.630
		2.5	30	201	181	2.000
		3.0	29	242	215	2.370
38	0.15	4.0	27	322	280	3.060
		5.0	25	357	342	3.690
		6.0	23	419	401	4.290
		* 2.5	33	186	168	2.189
		3.0	32	223	200	2.589
42	0.2	4.0	30	297	260	3.350
		5.0	28	332	318	4.075
		6.0	26	390	373	4.740
		7.0	24	446	427	5.350
		* 2.0	28	134	124	1.973
42	0.2	3.0	26	203	181	2.890
		4.0	34	269	237	3.750

* Tube which need a support sleeve for assembly in SUPERLOK DIN Tube Fittings.

Tubing Guide

Allowed Stainless Steel Tubes

- For steel tubes in stainless steel we advise to use calibrated seamless cold drawn without welding tubes 1.4571 as per DIN 17458 or ASTM A269.
- Maximum allowed hardness on the outside diameter of the tube is 85 HRB.
- The indicated pressure are to be intended a constant pressure rate and with temperatures between -60° and 200°.

Tube O.D (mm)	Tolerance (mm)	Wall Thickness (t mm)	Weight	Design Pressure
			(kg/m)	DIN 2413-1 (bar)
4	± 0.1	0.5	0.048	326
		1.0	0.076	544
6	± 0.1	1.0	0.125	406
		1.5	0.169	572
		2.0	0.200	721
8	± 0.1	1.0	0.225	347
		1.5	0.244	449
		2.0	0.301	572
		2.5	0.344	686
10	± 0.1	1.0	0.225	294
		1.5	0.319	389
		2.0	0.401	498
		2.5	0.469	601
12	± 0.08	3.0	0.526	694
		* 1.0	0.275	245
		1.5	0.394	368
		2.0	0.500	426
		2.5	0.595	516
14	± 0.08	3.0	0.676	601
		3.5	0.745	679
		1.5	0.469	315
		2.0	0.601	420
		2.5	0.720	452
15	± 0.08	3.0	0.826	529
		3.5	0.920	601
		1.5	0.507	294
		2.0	0.651	392
16	± 0.08	3.0	0.902	498
		* 1.5	0.544	275
		2.0	0.702	368
		2.5	0.845	402
18	± 0.08	3.0	0.977	471
		* 1.5	0.619	245

Tube O.D (mm)	Tolerance (mm)	Wall Thickness (t mm)	Weight	Design Pressure
			(kg/m)	DIN 2413-1 (bar)
18	± 0.08	2.0	0.801	326
		2.5	0.971	409
		3.0	1.128	426
20	± 0.08	** 2.0	0.902	294
		2.5	1.095	368
		3.0	1.277	389
		3.5	1.446	444
		4.0	1.602	498
22	± 0.08	* 2.0	1.001	267
		2.5	1.220	334
		3.0	1.427	401
25	± 0.08	* 2.0	1.151	236
		2.5	1.408	294
		3.0	1.653	352
		4.0	2.104	411
		4.5	2.310	456
28	± 0.08	* 2.0	1.301	210
		2.5	1.596	263
		3.0	1.878	315
30	± 0.08	* 2.0	1.402	175
		2.5	1.721	245
		3.0	2.028	294
		4.0	2.604	392
35	± 0.15	* 2.0	2.222	168
		2.5	2.034	210
		3.0	2.403	252
		4.0	3.104	336
38	± 0.15	* 3.0	2.628	232
		4.0	3.405	310
		5.0	4.131	387
42	± 0.2	3.0	2.929	210
		4.0	3.806	280

* Tube which need a support sleeve for assembly in SUPERLOK DIN Tube Fittings.

** Tubes to be used for ISO 8434-2 / SAE J514 norm only.

Stud Ends & Tapered Hold Forms

Form of Stud Ends

Form A (DIN3852 Part 1&2) with sealing by washer

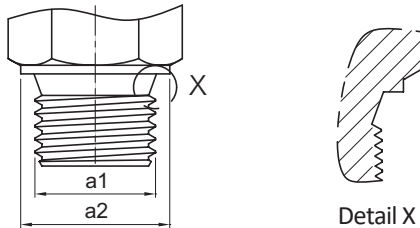

Form B (DIN 3852 Part 1&2) with sealing by compression against face of body.

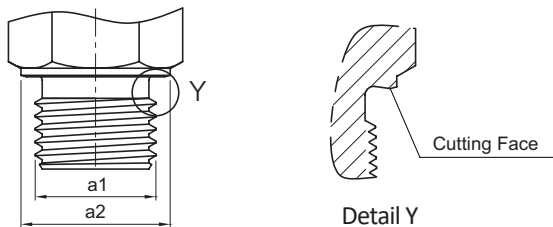

Form E (DIN 3852 Part 11) with sealing by DIN 3869 ring seals (*ED-Ring)

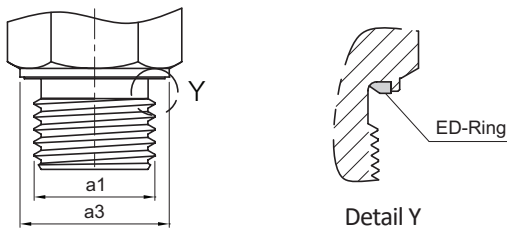

Form F (DIN 3852 Part 3) with sealing by *O-Ring

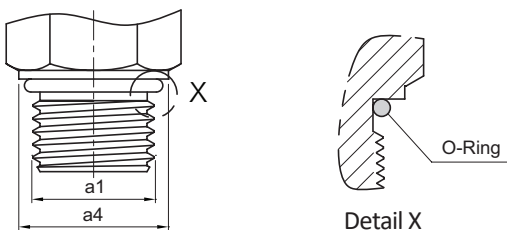

* ED-Ring & O-Ring Seals made of NBR Standard (-20°C to 100°C)
Other Sealing Materials are available on Request.

Form C (DIN 3852 Part 1&2) with sealing in tapered thread

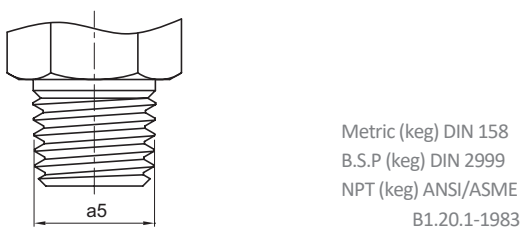

Thread size for Form A, B, E, F Stud Ends

a1	a2	a3 ⁰ _{-0.2}	a4 ±0.1
M8 x 1.0	-	-	10.9
M10 x 1.0	14.0	13.9	12.9
M12 x 1.5	17.0	16.9	16.9
M14 x 1.5	19.0	18.9	18.9
M16 x 1.5	21.0	21.9	20.9
M18 x 1.5	23.0	23.9	22.9
M20 x 1.5	25.0	25.9	24.9
M22 x 1.5	27.0	26.9	26.9
M26 x 1.5	31.0	31.9	30.9
M27 x 2.0	32.0	31.9	31.9
M33 x 2.0	39.0	39.9	37.9
M42 x 2.0	49.0	49.9	47.9
M48 x 2.0	55.0	54.9	54.9
G 1/8	14.0	13.9	-
G 1/4	18.0	18.9	-
G 3/8	22.0	21.9	-
G 1/2	26.0	26.9	-
G 3/4	32.0	31.9	-
G 1	39.0	39.9	-
G 1-1/4	49.0	49.9	-
G 1-1/2	55.0	54.9	-
7/16-20UNF	-	-	14.4
9/16-18UNF	-	-	17.6
3/4-16UNF	-	-	22.3
7/8-14UNF	-	-	25.5
1 1/16-12UN	-	-	31.9
1 5/16-12UN	-	-	38.2
1 5/8-12UN	-	-	47.4

Thread size for Form C Stud Ends

a5		
M8 x 1.0 keg.	1/8 NPT	R 1/8 keg.
M10 x 1.0 keg.	1/4 NPT	R 1/4 keg.
M12 x 1.5 keg.	3/8 NPT	R 3/8 keg.
M14 x 1.5 keg.	1/2 NPT	R 1/2 keg.
M16 x 1.5 keg.	3/4 NPT	R 3/4 keg.
M18 x 1.5 keg.	1 NPT	R 1 keg.
M20 x 1.5 keg.	1-1/4 NPT	R 1-1/4 keg.
M22 x 1.5 keg.	1-1/2 NPT	R 1-1/2 keg.

Stud Ends & Tapered Hold Forms

Form of Tapped Holes

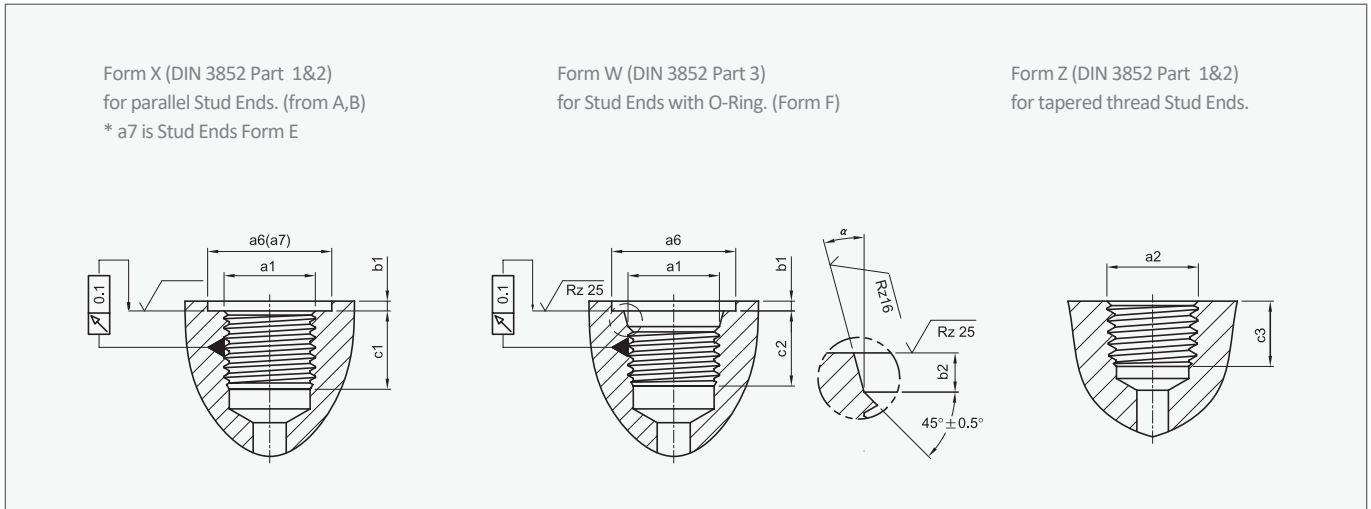

Thread size for		a6 min.	a7	b1 max.	a2 ^{+0.4} ₀	C1 min.	C1 min.	C3 min.	α°±0.1°
Form X,W Tapped Holes a1	Form Z Tapped Holes a2								
M8 x 1.0	M8 x 1.0 keg.	13.0	-	1.0	1.6	-	10.0	5.5	12.0
M10 x 1.0	M10 x 1.0 keg.	15.0	15.0	1.0	1.6	8.0	10.0	5.5	12.0
M12 x 1.5	M12 x 1.5 keg.	18.0	18.0	1.5	2.4	12.0	11.5	8.5	12.0
M14 x 1.5	M14 x 1.5 keg.	20.0	20.0	1.5	2.4	12.0	11.5	8.5	15.0
M16 x 1.5	M16 x 1.5 keg.	22.0	23.0	1.5	2.4	12.0	13.0	8.5	15.0
M18 x 1.5	M18 x 1.5 keg.	24.0	25.0	2.0	2.4	12.0	14.5	8.5	15.0
M20 x 1.5	M20 x 1.5 keg.	26.0	27.0	2.0	2.4	14.0	15.0	10.5	15.0
M22 x 1.5	M22 x 1.5 keg.	28.0	28.0	2.5	2.4	14.0	15.5	10.5	15.0
M26 x 1.5	-	32.0	33.0	2.5	3.1	16.0	16.0	-	15.0
M27 x 2.0	-	33.0	33.0	2.5	3.1	16.0	19.0	-	15.0
M33 x 2.0	-	40.0	41.0	2.5	3.1	18.0	19.0	-	15.0
M42 x 2.0	-	50.0	51.0	2.5	3.1	20.0	19.5	-	15.0
M48 x 2.0	-	56.0	56.0	2.5	3.1	22.0	22.0	-	15.0
G 1/8	1/8 NPT	15.0	15.0	1.0	-	8.0	-	6.9	-
G 1/4	1/4 NPT	19.0	20.0	1.5	-	12.0	-	10.0	-
G 3/8	3/8 NPT	23.0	23.0	2.0	-	12.0	-	10.3	-
G 1/2	1/2 NPT	27.0	28.0	2.5	-	14.0	-	13.6	-
G 3/4	3/4 NPT	33.0	33.0	2.5	-	16.0	-	14.1	-
G 1	1 NPT	40.0	41.0	2.5	-	18.0	-	16.8	-
G 1-1/4	1-1/4 NPT	50.0	51.0	2.5	-	20.0	-	17.3	-
G 1-1/2	1-1/2 NPT	56.0	56.0	2.5	-	22.0	-	17.3	-
7/16-20UNF	R 1/8 keg.	21.0	-	1.6	2.4	-	11.5	5.5	12.0
9/16-18UNF	R 1/4 keg.	25.0	-	1.6	2.5	-	12.7	8.5	12.0
3/4-16UNF	R 3/8 keg.	30.0	-	2.4	2.5	-	14.3	8.5	15.0
7/8-14UNF	R 1/2 keg.	34.0	-	2.4	2.5	-	16.7	10.5	15.0
1 1/16-12UN	R 3/4 keg.	41.0	-	2.4	3.3	-	19.0	13.0	15.0
1 5/16-12UN	R 1 keg.	49.0	-	3.2	3.3	-	19.0	16.0	15.0
1 5/8-12UN	R 1-1/4 keg.	58.0	-	3.2	3.3	-	19.0	17.0	15.0
	R 1-1/2 keg.	-	-	-	-	-	-	17.0	-

Assembly in Fitting Body

The use of pre-assembled bodies or pre-assembly tools are strongly recommended for all assemblies. Stainless steel tube end fittings as well as standpipe hose ends must be pre-assembled in a pre-assembly tool.

A) Preparing the tube

1 Minimum height H for straight tube end

Minimum length L for short piece of tube

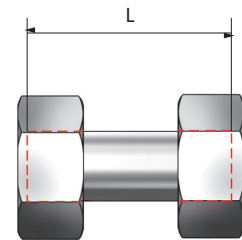
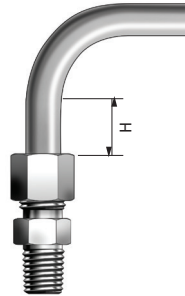

The portion of straight tube H must not deviate from roundness and straightness to the extent that the tube tolerances in DIN 2391 are exceeded.

Series	LL				L										S									
	4	5	6	8	6	8	10	12	15	18	22	28	35	42	6	8	10	12	14	16	20	25	30	38
H (min.)	24	25	25	26	31	31	33	33	36	38	41	41	48	48	35	35	37	37	43	43	50	54	58	65
L (min.)	30	32	32	33	39	39	42	42	45	48	53	53	60	60	44	44	47	47	54	54	63	68	73	82

2

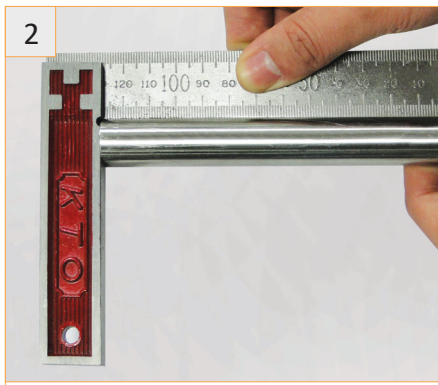

Saw off tube square
1/2° angle tolerance to the tube axis.

3 **Attention** : Do not use tube cutter!



a) tube cut with tube cutter :
heavy burr / bevel cut



b) sawed off tube:
very little burr



4



Lightly deburr inside and outside edge.
Level up 0.3mm x 45° (0.012" x 45°)
permissible.

B) Preparing fittings parts with lubricants

5

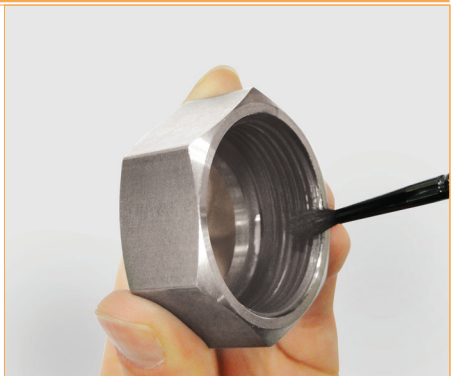
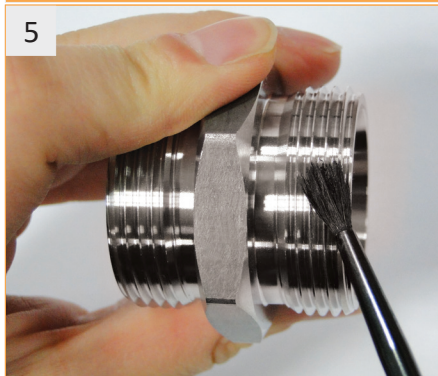

Lubricate thread and cone of fitting body, also compression ring and thread of nut.

Assembly in Fitting Body

C) Components

6



Slip nut and compression ring over tube end.

7

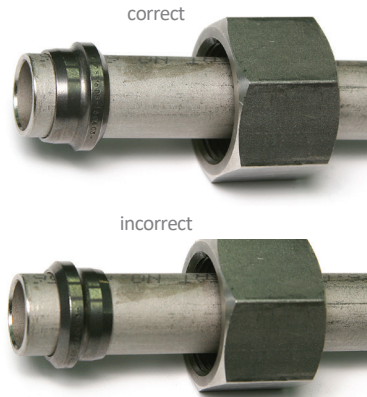

Ensure compression ring and nut are facing the right way.

D) Assembly

8

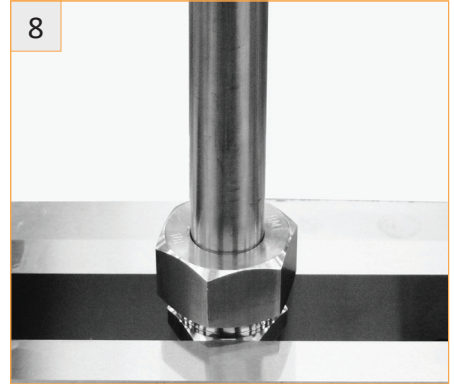

Screw nut manually on to fitting body until fingertight. Hold tube against the shoulder in the cone of fitting body.

9



To measure the prescribed turns of the nut, mark nut and tube.

10



Tighten nut 1-1/2 turns (Tube must not turn with nut). Stop edges limits over tightening by increasing tightening torque.

E) Check

11

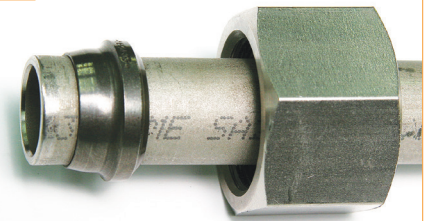

Loosen nut. Remove tube from fitting and check if a visible collar fills space in front of 1st cutting edge completely. If not, tighten slightly more. If dose not matter if ring can be roated on tube end.

F) Final assembly

12

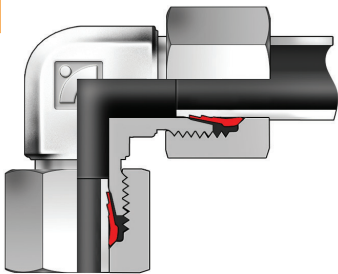

Final assembly of all pre-assembled fittings (DSE, DSBT, DSRT, DSRA) made in the appropriate body (well lubricated) with at least 1/4 turn of the nut beyond the point of a clearly perceptible resistance.

G) Repeated assembly

13

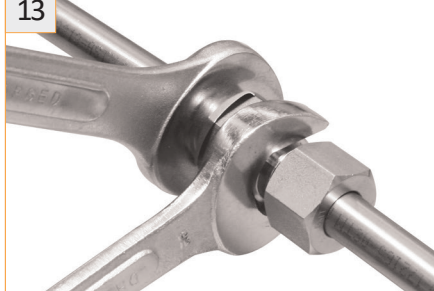

On remaking joints, nut to be tightened without increased effort. Fitting body to be held tight.

* After dismantling the tube ends for inspection they should be refitted into the same inner cone of the fitting body in which assembly was carried out.

Ordering Information

Example 1	Male Connector					
DCM - 10 L - 02GED - V - B						
1 2 3 4 5 6						

Example 2	Reducing Union Tee					
DRUT - 30 S - 20 S - 37 L - B						
1 2 3 2 3 2 3 6						

Ordering numbers for Tees and Crosses

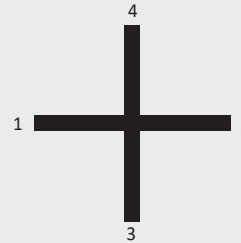

- TEE: First indicate the size of the run (1 to 2) and then the size of the branch (3).
- CROSS: First indicate the size of the run (1 to 2) and then the size of the branch (3 to 4).

1. Type of Fitting

Please refer to SUPERLOK DIN Tube Fitting Index on 2.

2. Tube O.D

Tube O.D	4mm	6mm	8mm	10mm	12mm	15mm	16mm	18mm	20mm	22mm	25mm	28mm	30mm	35mm	38mm	42mm
Designator	4	6	8	10	12	15	16	18	20	22	25	28	30	35	38	42

3. Series

Series	Very Light	Light	Heavy
Designator	LL	L	S

4. Thread Size and Type *

Pipe Thread

Thread Type	Thread Size									Specification
	1/8	1/4	3/8	1/2	3/4	1	1-1/4	1-1/2	2	
NPT	01N	02N	03N	04N	06N	08N	10N	12N	16N	ANSI/ASME B1.20.1
ISO/BSP Parallel	01G	02G	03G	04G	06G	08G	10G	12G	16G	ISO228 (DIN259)
ISO/BSP Tapered	01R	02R	03R	04R	06R	08R	10R	12R	16R	DIN - 2999

Metric Thread

Thread Type	Thread Size									Specification
	M8 x 1.0	M10 x 1.0	M12x 1.5	M14 x 1.5	M16 x 1.5	M18 x 1.5	M42 x 2.0	M48 x 2.0	
Metric Parallel	M8	M10	M12	M14	M16	M18	M42	M48	DIN - 13
Metric Tapered(Keg)	M8K	M10K	M12K	M14K	M16K	M18K	M42K	M48K	DIN - 158

Unified Thread

Specification	Thread Size							
	7/16-20UNF	9/16-18UNF	3/4-16UNF	7/8-14UNF	1 1/16-12UN	1 5/16-12UN	1 5/8-12UN	2
ASME B1.1	4U	6U	8U	10U	12U	16U	20U	

* For the thread types not specified above, please refer to part numbers on the dimension tables from 12 to 49.

5. Seat Material

- (Blank) = NBR (Standard)
- V = FPM
- PT = PTFE

6. Fitting Material

Carbon Steel (DIN3859)	316 Stainless Steel (DIN17440/1.4571)	Brass
C	(Blank)	B

※ For special sizes and configurations, please consult BMT (SUPERLOK) sales representative.

DU
Union

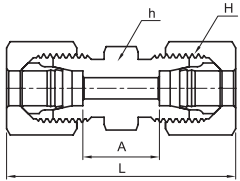
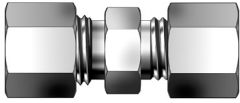

Series	Part No.	Tube O.D.	Dimension			
			H	h	L	A
LL Very Light PN 100	DU-04LL	4	10.0	9.0	31.0	12.0
	DU-06LL	6	12.0	11.0	32.0	9.0
	DU-08LL	8	14.0	12.0	35.0	12.0
	DU-10LL	10	17.0	14.0	35.0	12.0
	DU-12LL	12	19.0	17.0	35.0	11.0
L Light PN 315	DU-06L	6	14.0	12.0	39.0	10.0
	DU-08L	8	17.0	14.0	40.0	11.0
	DU-10L	10	19.0	17.0	42.0	13.0
	DU-12L	12	22.0	19.0	43.0	14.0
	DU-15L	15	27.0	24.0	46.0	16.0
PN 160	DU-18L	18	32.0	27.0	48.0	16.0
	DU-22L	22	36.0	32.0	52.0	20.0
	DU-28L	28	41.0	41.0	54.0	21.0
	DU-35L	35	50.0	46.0	63.0	20.0
S Heavy PN 630	DU-42L	42	60.0	55.0	66.0	21.0
	DU-06S	6	17.0	14.0	45.0	16.0
	DU-08S	8	19.0	17.0	47.0	18.0
	DU-10S	10	22.0	19.0	49.0	17.0
	DU-12S	12	24.0	22.0	51.0	19.0
PN 400	DU-14S	14	27.0	24.0	57.0	22.0
	DU-16S	16	30.0	27.0	57.0	21.0
	DU-20S	20	36.0	32.0	66.0	23.0
PN 315	DU-25S	25	46.0	41.0	74.0	26.0
	DU-30S	30	50.0	46.0	80.0	27.0
	DU-38S	38	60.0	55.0	90.0	29.0

- Dimensions and Drawings are for reference only and are subject to change without prior notice.
- Unless otherwise specified, all dimensions are in millimeters.
- Sizes, pressure classes, and end connections not listed are available upon request.
- Length given approximate figure with tightened nut.

DUE

Union Elbow

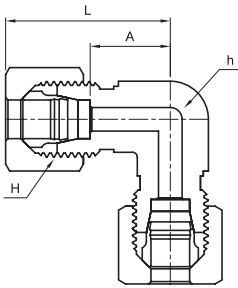
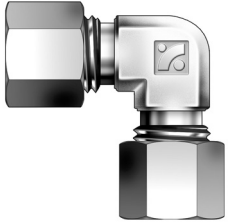

Series	Part No.	Tube O.D.	Dimension			
			H	h	L	A
LL Very Light PN 100	DUE-04LL	4	10.0	9.0	21.0	11.0
	DUE-06LL	6	12.0	9.0	21.0	9.5
	DUE-08LL	8	14.0	12.0	23.0	11.5
	DUE-10LL	10	17.0	14.0	24.0	12.5
	DUE-12LL	12	19.0	17.0	25.0	13.0
L Light PN 315	DUE-06L	6	14.0	12.0	27.0	12.0
	DUE-08L	8	17.0	12.0	29.0	14.0
	DUE-10L	10	19.0	14.0	30.0	15.0
	DUE-12L	12	22.0	17.0	32.0	17.0
	DUE-15L	15	27.0	19.0	36.0	21.0
PN 160	DUE-18L	18	32.0	24.0	40.0	23.5
	DUE-22L	22	36.0	27.0	44.0	27.5
	DUE-28L	28	41.0	36.0	47.0	30.5
	DUE-35L	35	50.0	41.0	56.0	34.5
S Heavy PN 630	DUE-42L	42	60.0	50.0	63.0	40.0
	DUE-06S	6	17.0	12.0	31.0	16.0
	DUE-08S	8	19.0	14.0	32.0	17.0
	DUE-10S	10	22.0	17.0	34.0	17.5
	DUE-12S	12	24.0	17.0	38.0	21.5
PN 400	DUE-14S	14	27.0	19.0	40.0	22.0
	DUE-16S	16	30.0	24.0	43.0	24.5
	DUE-20S	20	36.0	27.0	48.0	26.5
PN 315	DUE-25S	25	46.0	36.0	54.0	30.0
	DUE-30S	30	50.0	41.0	62.0	35.5
PN 315	DUE-38S	38	60.0	50.0	72.0	41.0

- Dimensions and Drawings are for reference only and are subject to change without prior notice.
- Unless otherwise specified, all dimensions are in millimeters.
- Sizes, pressure classes, and end connections not listed are available upon request.
- Length given approximate figure with tightened nut.

DRU

Reducing Union

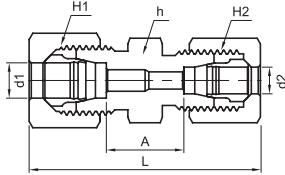
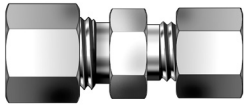

Series	Part No.	Tube OD		Dimension				
		d1	d2	H1	H2	h	L	A
L Light PN 315	DRU-08L-06L	8	6	17.0	14.0	14.0	40.0	11.0
	DRU-10L-06L	10	6	19.0	14.0	17.0	41.0	12.0
	DRU-10L-08L	10	8	19.0	17.0	17.0	41.0	12.0
	DRU-12L-06L	12	6	22.0	14.0	19.0	42.0	13.0
	DRU-12L-08L	12	8	22.0	17.0	19.0	42.0	13.0
	DRU-12L-10L	12	10	22.0	19.0	19.0	43.0	14.0
	DRU-15L-10L	15	10	27.0	19.0	24.0	45.0	15.0
	DRU-15L-12L	15	12	27.0	22.0	24.0	45.0	15.0
	DRU-18L-10L	18	10	32.0	19.0	27.0	46.0	15.5
	DRU-18L-12L	18	12	32.0	22.0	27.0	46.0	15.5
PN 160	DRU-18L-15L	18	15	32.0	27.0	27.0	48.0	16.5
	DRU-22L-12L	22	12	36.0	22.0	32.0	48.0	17.5
	DRU-22L-15L	22	15	36.0	27.0	32.0	50.0	18.5
	DRU-22L-18L	22	18	36.0	32.0	32.0	50.0	18.0
	DRU-28L-18L	28	18	41.0	32.0	41.0	52.0	19.0
	DRU-28L-22L	28	22	41.0	36.0	41.0	54.0	21.0
S Heavy PN 630	DRU-35L-22L	35	22	50.0	36.0	46.0	59.0	21.0
	DRU-35L-28L	35	28	50.0	41.0	46.0	59.0	21.0
	DRU-08S-06S	8	6	19.0	17.0	17.0	47.0	18.0
	DRU-10S-06S	10	6	22.0	17.0	19.0	48.0	17.5
	DRU-10S-08S	10	8	22.0	19.0	19.0	48.0	17.5
	DRU-12S-06S	12	6	24.0	17.0	22.0	50.0	19.5
	DRU-12S-08S	12	8	24.0	19.0	22.0	50.0	19.5
	DRU-12S-10S	12	10	24.0	22.0	22.0	51.0	19.0
PN 400	DRU-14S-10S	14	10	27.0	22.0	24.0	54.0	20.5
	DRU-14S-12S	14	12	27.0	24.0	24.0	54.0	20.5
	DRU-16S-12S	16	12	30.0	24.0	27.0	54.0	20.0
	DRU-16S-14S	16	14	30.0	27.0	27.0	57.0	21.5
	DRU-20S-10S	20	10	36.0	22.0	32.0	60.0	22.0
	DRU-20S-12S	20	12	36.0	24.0	32.0	60.0	22.0
	DRU-20S-16S	20	16	36.0	30.0	32.0	63.0	23.0
	DRU-25S-16S	25	16	46.0	30.0	41.0	68.0	25.0
PN 315	DRU-25S-20S	25	20	46.0	36.0	41.0	71.0	25.5
	DRU-30S-20S	30	20	50.0	36.0	46.0	74.0	26.0
	DRU-30S-25S	30	25	50.0	46.0	46.0	77.0	26.5
PN 315	DRU-38S-30S	38	30	60.0	50.0	55.0	87.0	29.5

- Dimensions and Drawings are for reference only and are subject to change without prior notice.
- Unless otherwise specified, all dimensions are in millimeters.
- Sizes, pressure classes, and end connections not listed are available upon request.
- Length given approximate figure with tightened nut.

DUT

Union Tee

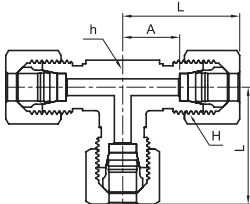

Series	Part No.	Tube O.D.	Dimension			
			H	h	L	A
LL Very Light PN 100	DUT-04LL	4	10.0	9.0	21.0	11.0
	DUT-06LL	6	12.0	9.0	21.0	9.5
	DUT-08LL	8	14.0	12.0	23.0	11.5
	DUT-10LL	10	17.0	14.0	24.0	12.5
	DUT-12LL	12	19.0	14.0	27.0	15.0
L Light PN 315	DUT-06L	6	14.0	12.0	27.0	12.0
	DUT-08L	8	17.0	12.0	29.0	14.0
	DUT-10L	10	19.0	14.0	30.0	15.0
	DUT-12L	12	22.0	17.0	32.0	17.0
	DUT-15L	15	27.0	19.0	36.0	21.0
PN 160	DUT-18L	18	32.0	24.0	40.0	23.5
	DUT-22L	22	36.0	27.0	44.0	27.5
	DUT-28L	28	41.0	36.0	47.0	30.5
	DUT-35L	35	50.0	41.0	56.0	34.5
S Heavy PN 630	DUT-42L	42	60.0	50.0	63.0	40.0
	DUT-06S	6	17.0	12.0	31.0	16.0
	DUT-08S	8	19.0	14.0	32.0	17.0
	DUT-10S	10	22.0	17.0	34.0	17.5
PN 400	DUT-12S	12	24.0	17.0	38.0	21.5
	DUT-14S	14	27.0	19.0	40.0	22.0
	DUT-16S	16	30.0	24.0	43.0	24.5
PN 315	DUT-20S	20	36.0	27.0	48.0	26.5
	DUT-25S	25	46.0	36.0	54.0	30.0
	DUT-30S	30	50.0	41.0	62.0	35.5
PN 315	DUT-38S	38	60.0	50.0	72.0	41.0

DUC

Union Cross

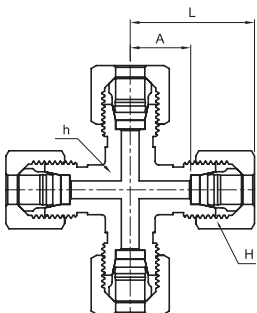

Series	Part No.	Tube O.D.	Dimension			
			H	h	L	A
LL Very Light PN 100	DUC-04LL	4	10.0	9.0	21.0	11.0
	DUC-06LL	6	12.0	9.0	21.0	9.5
	DUC-08LL	8	14.0	12.0	23.0	11.5
	DUC-10LL	10	17.0	14.0	24.0	12.5
	DUC-12LL	12	19.0	14.0	27.0	15.0
L Light PN 315	DUC-06L	6	14.0	12.0	27.0	12.0
	DUC-08L	8	17.0	12.0	29.0	14.0
	DUC-10L	10	19.0	14.0	30.0	15.0
	DUC-12L	12	22.0	17.0	32.0	17.0
	DUC-15L	15	27.0	19.0	36.0	21.0
PN 160	DUC-18L	18	32.0	24.0	40.0	23.5
	DUC-22L	22	36.0	27.0	44.0	27.5
	DUC-28L	28	41.0	36.0	47.0	30.5
	DUC-35L	35	50.0	41.0	56.0	34.5
S Heavy PN 630	DUC-42L	42	60.0	50.0	63.0	40.0
	DUC-06S	6	17.0	12.0	31.0	16.0
	DUC-08S	8	19.0	14.0	32.0	17.0
	DUC-10S	10	22.0	17.0	34.0	17.5
PN 400	DUC-12S	12	24.0	17.0	38.0	21.5
	DUC-14S	14	27.0	19.0	40.0	22.0
	DUC-16S	16	30.0	24.0	43.0	24.5
PN 315	DUC-20S	20	36.0	27.0	48.0	26.5
	DUC-25S	25	46.0	36.0	54.0	30.0
	DUC-30S	30	50.0	41.0	62.0	35.5
PN 315	DUC-38S	38	60.0	50.0	72.0	41.0

- Dimensions and Drawings are for reference only and are subject to change without prior notice.
- Unless otherwise specified, all dimensions are in millimeters.
- Sizes, pressure classes, and end connections not listed are available upon request.
- Length given approximate figure with tightened nut.

DRUT

Reducing Union Tee

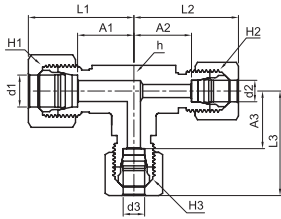

Series	Part No.	Tube OD			Dimension										
		d1	d2	d3	H1	H2	H3	h	L1	L2	L3	A1	A2	A3	
L Light	DRUT-06L-08L	6	6	8	14	14	17	14	29	29	29	14.0	14.0	14.0	
	PN 316	DRUT-08L-06L	8	8	6	17	17	14	14	29	29	29	14.0	14.0	14.0
PN 315	DRUT-06L-10L	6	6	10	14	14	19	14	30	30	30	15.0	15.0	15.0	
	DRUT-08L-10L	8	8	10	17	17	19	14	30	30	30	15.0	15.0	15.0	
	DRUT-10L-06L	10	10	6	19	19	14	14	30	30	30	15.0	15.0	15.0	
	DRUT-10L-08L	10	10	8	19	19	17	14	30	30	30	15.0	15.0	15.0	
	DRUT-10L-06L-10L	10	6	10	19	14	19	14	30	30	30	15.0	15.0	15.0	
PN 315	DRUT-08L-12L	8	8	12	17	17	22	17	32	32	32	17.0	17.0	17.0	
	DRUT-12L-06L	12	12	6	22	22	14	17	32	32	32	17.0	17.0	17.0	
	DRUT-12L-08L-08L	12	8	8	22	17	17	17	32	32	32	17.0	17.0	17.0	
	DRUT-12L-08L	12	12	8	22	22	17	17	32	32	32	17.0	17.0	17.0	
	DRUT-12L-10L-10L	12	10	10	22	19	19	17	32	32	32	17.0	17.0	17.0	
	DRUT-12L-10L	12	12	10	22	22	19	17	32	32	32	17.0	17.0	17.0	
	DRUT-12L-10L-12L	12	10	12	22	19	22	17	32	32	32	17.0	17.0	17.0	
PN 315	DRUT-10L-15L	10	10	15	19	19	27	19	36	36	36	21.0	21.0	21.0	
	DRUT-12L-15L	12	12	15	22	22	27	19	36	36	36	21.0	21.0	21.0	
	DRUT-15L-06L	15	15	6	27	27	14	19	36	36	36	21.0	21.0	21.0	
	DRUT-15L-10L	15	15	10	27	27	19	19	36	36	36	21.0	21.0	21.0	
	DRUT-15L-12L-12L	15	12	12	27	22	22	19	36	36	36	21.0	21.0	21.0	
	DRUT-15L-12L	15	15	12	27	27	22	19	36	36	36	21.0	21.0	21.0	
	DRUT-15L-12L-15L	15	12	15	27	22	27	19	36	36	36	21.0	21.0	21.0	
PN 315	DRUT-12L-18L	12	12	18	22	22	32	24	39	39	40	24.0	24.0	23.5	
	DRUT-18L-10L-10L	18	10	10	32	19	19	24	40	39	39	23.5	24.0	24.0	
	DRUT-18L-10L	18	18	10	32	32	19	24	40	40	39	23.5	23.5	24.0	
	DRUT-18L-12L	18	18	12	32	32	22	24	40	40	39	23.5	23.5	24.0	
	DRUT-18L-15L	18	18	15	32	32	27	24	40	40	39	23.5	23.5	24.0	
	DRUT-18L-10L-18L	18	10	18	32	19	32	27	40	39	40	23.5	24.0	23.5	
PN 160	DRUT-22L-10L	22	22	10	36	36	19	27	44	44	43	27.5	27.5	28.0	
	DRUT-22L-12L	22	22	12	36	36	22	27	44	44	43	27.5	27.5	28.0	
	DRUT-22L-15L-15L	22	15	15	36	27	27	27	44	43	43	27.5	28.0	28.0	
	DRUT-22L-15L	22	22	15	36	36	27	27	44	44	43	27.5	27.5	28.0	
	DRUT-22L-18L-18L	22	18	18	36	32	32	27	44	44	44	27.5	27.5	27.5	
	DRUT-22L-18L	22	22	18	36	36	32	27	44	44	44	27.5	27.5	27.5	
	DRUT-22L-18L-22L	22	18	22	36	32	36	27	44	44	44	27.5	27.5	27.5	
PN 160	DRUT-28L-10L	28	28	10	41	41	19	36	47	44	46	30.5	30.5	31.0	
	DRUT-28L-12L	28	28	12	41	41	22	36	47	47	46	30.5	30.5	31.0	
	DRUT-28L-15L	28	28	15	41	41	27	36	47	47	46	30.5	30.5	31.0	
	DRUT-28L-18L	28	28	18	41	41	32	36	47	47	47	30.5	30.5	30.5	
	DRUT-28L-22L-22L	28	22	22	41	36	36	36	47	47	47	30.5	30.5	30.5	
	DRUT-28L-22L	28	28	22	41	41	36	36	47	47	47	30.5	30.5	30.5	
	DRUT-28L-22L	28	28	22	41	41	36	36	47	47	47	30.5	30.5	30.5	
S Heavy	DRUT-10S-06S	10	10	6	22	22	17	17	34	34	33	17.5	17.5	18.0	
	PN 630	DRUT-12S-08S-08S	12	8	8	24	19	19	17	38	37	37	21.5	22.0	22.0
	DRUT-12S-08S	12	12	8	24	24	19	17	38	38	37	21.5	21.5	22.0	
PN 400	DRUT-12S-10S	12	12	10	24	24	22	17	38	38	38	21.5	21.5	21.5	
	DRUT-12S-16S	12	12	16	24	24	30	24	42	42	43	25.5	25.5	24.5	
	DRUT-16S-06S	16	16	6	30	30	17	24	43	43	41	24.5	24.5	26.0	
	DRUT-16S-08S	16	16	8	30	30	19	24	43	43	41	24.5	24.5	26.0	
	DRUT-16S-10S	16	16	10	30	30	22	24	43	43	42	24.5	24.5	25.5	
	DRUT-16S-12S	16	16	12	30	30	24	24	43	43	42	24.5	24.5	25.5	
PN 400	DRUT-16S-20S	16	16	20	30	30	36	27	47	47	48	28.5	28.5	26.5	
	DRUT-20S-10S	20	20	10	36	36	22	27	48	48	46	26.5	26.5	29.5	
	DRUT-20S-12S	20	20	12	36	36	24	27	48	48	46	26.5	26.5	29.5	
	DRUT-20S-16S	20	20	16	36	36	30	27	48	48	47	26.5	26.5	28.5	
PN 400	DRUT-20S-25S	20	20	25	36	36	46	36	53	53	54	31.5	31.5	30.0	
	DRUT-25S-16S	25	25	16	46	46	30	36	54	54	52	30.0	30.0	33.5	
	DRUT-25S-20S	25	25	20	46	46	36	36	54	54	53	30.0	30.0	31.5	
	DRUT-25S-30S	25	25	30	46	46	50	41	61	61	62	37.0	37.0	35.5	

- Dimensions and Drawings are for reference only and are subject to change without prior notice.
- Unless otherwise specified, all dimensions are in millimeters.
- Sizes, pressure classes, and end connections not listed are available upon request.
- Length given approximate figure with tightened nut.

DBHU
Bulkhead Union

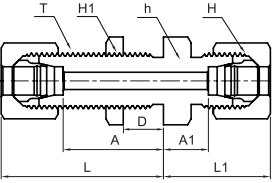
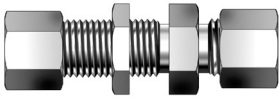

D=16mm Max Bulkhead thickness

Series	Part No.	Tube O.D.	Dimension							
			H	H1	h	L	L1	A	A1	T
L Light PN 315	DBHU-06L	6	14.0	17.0	17.0	42.0	22.0	27.0	7.0	M12 x 1.5
	DBHU-08L	8	17.0	19.0	19.0	42.0	23.0	27.0	8.0	M14 x 1.5
	DBHU-10L	10	19.0	22.0	22.0	43.0	25.0	28.0	10.0	M16 x 1.5
	DBHU-12L	12	22.0	24.0	24.0	44.0	25.0	29.0	10.0	M18 x 1.5
	DBHU-15L	15	27.0	30.0	27.0	46.0	27.0	31.0	12.0	M22 x 1.5
	DBHU-18L	18	32.0	36.0	32.0	49.0	30.0	32.5	13.5	M26 x 1.5
PN 160	DBHU-22L	22	36.0	41.0	36.0	51.0	33.0	34.5	16.5	M30 x 2.0
	DBHU-28L	28	41.0	46.0	41.0	52.0	35.0	35.5	18.5	M36 x 2.0
	DBHU-35L	35	50.0	55.0	50.0	58.0	40.0	36.5	18.5	M45 x 2.0
	DBHU-42L	42	60.0	65.0	60.0	59.0	42.0	36.0	19.0	M52 x 2.0
S Heavy PN 630	DBHU-06S	6	17.0	19.0	19.0	44.0	27.0	29.0	12.0	M14 x 1.5
	DBHU-08S	8	19.0	22.0	22.0	44.0	28.0	29.0	13.0	M16 x 1.5
	DBHU-10S	10	22.0	24.0	24.0	46.0	31.0	29.5	14.5	M18 x 1.5
	DBHU-12S	12	24.0	27.0	27.0	47.0	31.0	30.5	14.5	M20 x 1.5
PN 400	DBHU-14S	14	27.0	30.0	30.0	50.0	35.0	32.0	17.0	M22 x 1.5
	DBHU-16S	16	30.0	32.0	32.0	50.0	35.0	31.5	16.5	M24 x 1.5
	DBHU-20S	20	36.0	41.0	41.0	55.0	39.0	33.5	17.5	M30 x 2.0
PN 315	DBHU-25S	25	46.0	46.0	46.0	59.0	44.0	35.0	20.0	M36 x 2.0
	DBHU-30S	30	50.0	50.0	50.0	64.0	48.0	37.5	21.5	M42 x 2.0
PN 315	DBHU-38S	38	60.0	65.0	65.0	68.0	53.0	37.0	22.0	M52 x 2.0

DBUW
Welded Bulkhead Union

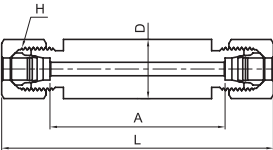

Series	Part No.	Tube O.D.	Dimension			
			H	D	L	A
L Light PN 315	DBUW-06L	6	14.0	18.0	85.0	56.0
	DBUW-08L	8	17.0	20.0	85.0	56.0
	DBUW-10L	10	19.0	22.0	87.0	58.0
	DBUW-12L	12	22.0	25.0	87.0	58.0
	DBUW-15L	15	27.0	28.0	100.0	70.0
	DBUW-18L	18	32.0	32.0	101.0	69.0
PN 315	DBUW-22L	22	36.0	36.0	105.0	73.0
	DBUW-28L	28	41.0	40.0	106.0	73.0
	DBUW-35L	35	50.0	50.0	114.0	71.0
	DBUW-42L	42	60.0	60.0	115.0	70.0
S Heavy PN 630	DBUW-06S	6	17.0	20.0	89.0	60.0
	DBUW-08S	8	19.0	22.0	89.0	60.0
	DBUW-10S	10	22.0	25.0	91.0	59.0
	DBUW-12S	12	24.0	28.0	91.0	59.0
PN 400	DBUW-14S	14	27.0	30.0	107.0	72.0
	DBUW-16S	16	30.0	35.0	107.0	71.0
	DBUW-20S	20	36.0	38.0	114.0	71.0
PN 315	DBUW-25S	25	46.0	45.0	120.0	72.0
	DBUW-30S	30	50.0	50.0	126.0	73.0
PN 315	DBUW-38S	38	60.0	60.0	133.0	72.0

- Dimensions and Drawings are for reference only and are subject to change without prior notice.
- Unless otherwise specified, all dimensions are in millimeters.
- Sizes, pressure classes, and end connections not listed are available upon request.
- Length given approximate figure with tightened nut.

DBUE

Bulkhead Union Elbow

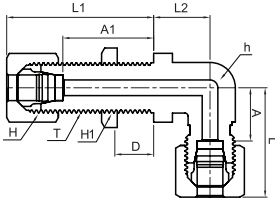
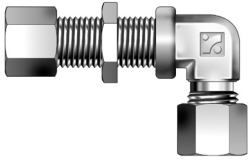

D=16mm Max Bulkhead thickness

Series	Part No.	Tube O.D.	Dimension								
			H	H1	h	L	L1	L2	A	A1	T
L Light PN 315	DBUE-06L	6	14.0	17.0	12.0	27.0	42.0	14.0	12.0	27.0	M12 x 1.5
	DBUE-08L	8	17.0	19.0	12.0	29.0	42.0	17.0	14.0	27.0	M14 x 1.5
	DBUE-10L	10	19.0	22.0	14.0	30.0	43.0	18.0	15.0	28.0	M16 x 1.5
	DBUE-12L	12	22.0	24.0	17.0	32.0	44.0	20.0	17.0	29.0	M18 x 1.5
	DBUE-15L	15	27.0	30.0	19.0	36.0	46.0	23.0	21.0	31.0	M22 x 1.5
PN 160	DBUE-18L	18	32.0	36.0	24.0	40.0	49.0	24.0	23.5	32.5	M26 x 1.5
	DBUE-22L	22	36.0	41.0	27.0	44.0	51.0	30.0	27.5	34.5	M30 x 2.0
	DBUE-28L	28	41.0	46.0	36.0	47.0	52.0	34.0	30.5	35.5	M36 x 2.0
	DBUE-35L	35	50.0	55.0	41.0	56.0	58.0	39.0	34.5	36.5	M45 x 2.0
S Heavy PN 630	DBUE-42L	42	60.0	65.0	50.0	63.0	59.0	43.0	40.0	36.0	M52 x 2.0
	DBUE-06S	6	17.0	19.0	12.0	31.0	44.0	17.0	16.0	29.0	M14 x 1.5
	DBUE-08S	8	19.0	22.0	14.0	32.0	44.0	18.0	17.0	29.0	M16 x 1.5
	DBUE-10S	10	22.0	24.0	17.0	34.0	46.0	20.0	17.5	29.5	M18 x 1.5
	DBUE-12S	12	24.0	27.0	17.0	38.0	47.0	21.0	21.5	30.5	M20 x 1.5
PN 400	DBUE-14S	14	27.0	30.0	19.0	40.0	50.0	23.0	22.0	32.0	M22 x 1.5
	DBUE-16S	16	30.0	32.0	24.0	43.0	50.0	24.0	24.5	31.5	M24 x 1.5
	DBUE-20S	20	36.0	41.0	27.0	48.0	55.0	30.0	26.5	33.5	M30 x 2.0
	DBUE-25S	25	46.0	46.0	36.0	54.0	59.0	34.0	30.0	35.0	M36 x 2.0
PN 315	DBUE-30S	30	50.0	50.0	41.0	62.0	64.0	39.0	35.5	37.5	M42 x 2.0
	DBUE-38S	38	60.0	65.0	50.0	72.0	68.0	43.0	41.0	37.0	M52 x 2.0

- Dimensions and Drawings are for reference only and are subject to change without prior notice.
- Unless otherwise specified, all dimensions are in millimeters.
- Sizes, pressure classes, and end connections not listed are available upon request.
- Length given approximate figure with tightened nut.

DCM-UO/MO (Unified/Metric Parallel)

Male Connector with O-Ring

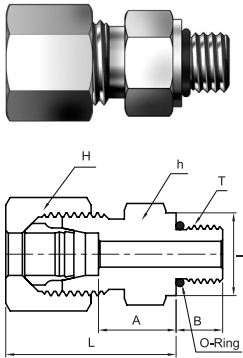

Unified Thread Type

Series	Part No.	Tube O.D.	Dimension						
			H	h	l	L	A	B	T
L Light PN 315	DCM-08L-04UO	8	17.0	17.0	14.4	25.0	9.0	10.0	7/16-20UNF-2A
	DCM-10L-04UO	10	19.0	17.0	14.4	26.0	10.0	11.0	7/16-20UNF-2A
	DCM-12L-06UO	12	22.0	19.0	17.6	26.0	10.0	11.0	9/16-18UNF-2A
	DCM-12L-08UO	12	22.0	24.0	22.3	28.0	11.0	13.0	3/4-16UNF-2A
	DCM-12L-10UO	12	22.0	27.0	25.5	29.0	12.7	14.3	7/8-14UNF-2A
	DCM-15L-08UO	15	27.0	24.0	22.3	29.0	11.0	14.0	3/4-16UNF-2A
	DCM-15L-10UO	15	27.0	27.0	25.5	30.0	12.7	15.3	7/8-14UNF-2A
	DCM-18L-08UO	18	32.0	27.0	22.3	31.0	11.0	14.5	3/4-16UNF-2A
PN 160	DCM-18L-10UO	18	32.0	27.0	25.5	31.0	12.7	14.8	7/8-14UNF-2A
	DCM-22L-10UO	22	36.0	32.0	25.5	33.0	12.7	16.8	7/8-14UNF-2A
	DCM-22L-12UO	22	36.0	32.0	31.9	33.0	15.0	16.5	1 1/16-12UN-2A
	DCM-22L-16UO	22	36.0	41.0	38.2	34.0	15.0	17.5	1 5/16-12UN-2A
	DCM-28L-12UO	28	41.0	41.0	31.9	34.0	15.0	17.5	1 1/16-12UN-2A
	DCM-28L-16UO	28	41.0	41.0	38.2	34.0	15.0	17.5	1 5/16-12UN-2A
	DCM-35L-16UO	35	50.0	46.0	38.2	39.0	15.0	17.5	1 5/16-12UN-2A
S Heavy PN 630	DCM-35L-20UO	35	50.0	50.0	47.7	39.0	15.0	17.5	1 5/8-12UN-2A
	DCM-42L-20UO	42	60.0	55.0	47.7	42.0	15.0	19.0	1 5/8-12UN-2A
	DCM-08S-04UO	8	19.0	17.0	16.0	30.0	9.0	15.0	7/16-20UNF-2A
	DCM-10S-06UO	10	22.0	19.0	17.6	31.0	10.0	14.5	9/16-18UNF-2A
PN 400	DCM-12S-06UO	12	24.0	22.0	17.6	31.0	10.0	14.5	9/16-18UNF-2A
	DCM-12S-08UO	12	24.0	24.0	22.3	34.0	11.0	17.5	3/4-16UNF-2A
	DCM-16S-08UO	16	30.0	24.0	22.3	34.0	11.0	15.5	3/4-16UNF-2A
	DCM-16S-10UO	16	30.0	27.0	25.5	37.0	12.7	18.8	7/8-14UNF-2A
	DCM-20S-08UO	20	36.0	32.0	22.3	42.0	11.0	20.5	3/4-16UNF-2A
	DCM-20S-10UO	20	36.0	32.0	25.5	42.0	12.7	20.8	7/8-14UNF-2A
	DCM-20S-12UO	20	36.0	32.0	31.9	42.0	15.0	20.5	1 1/16-12UN-2A
	DCM-25S-12UO	25	46.0	36.0	31.9	47.0	15.0	23.0	1 1/16-12UN-2A
PN 315	DCM-25S-16UO	25	46.0	41.0	38.2	47.0	15.0	23.0	1 5/16-12UN-2A
	DCM-30S-16UO	30	50.0	46.0	38.2	50.0	15.0	23.5	1 5/16-12UN-2A
	DCM-30S-20UO	30	50.0	50.0	47.7	50.0	15.0	23.5	1 5/8-12UN-2A

Metric Parallel Tread Type

Series	Part No.	Tube O.D.	Dimension						
			H	h	l	L	A	B	T
L Light PN 315	DCM-06L-MO10	6	14.0	14.0	-	23.0	10.0	8.5	M10 x 1.0
	DCM-08L-MO12	8	17.0	17.0	-	25.0	11.5	10.0	M12 x 1.5
	DCM-10L-MO14	10	19.0	19.0	-	26.0	11.5	11.0	M14 x 1.5
	DCM-12L-MO16	12	22.0	22.0	-	27.0	13.0	12.0	M16 x 1.5
	DCM-15L-MO18	15	27.0	24.0	-	29.0	14.5	13.5	M18 x 1.5
	DCM-18L-MO22	18	32.0	27.0	-	30.0	15.5	14.0	M22 x 1.5
PN 160	DCM-22L-MO26	22	36.0	32.0	-	32.0	16.0	16.0	M26 x 1.5
	DCM-28L-MO33	28	41.0	41.0	38.0	34.0	19.0	17.5	M33 x 2.0
	DCM-35L-MO42	35	50.0	50.0	48.0	39.0	19.5	17.5	M42 x 2.0
S Heavy PN 630	DCM-06S-MO12	6	17.0	17.0	-	27.0	11.5	12.0	M12 x 1.0
	DCM-08S-MO14	8	19.0	19.0	-	27.0	11.5	12.0	M14 x 1.5
	DCM-10S-MO16	10	22.0	22.0	-	29.0	13.0	12.5	M1 x 1.5
	DCM-12S-MO18	12	24.0	24.0	-	29.0	14.5	13.0	M18 x 1.5
PN 400	DCM-16S-MO22	16	30.0	27.0	-	33.0	15.5	15.0	M22 x 1.5
	DCM-20S-MO27	20	36.0	32.0	-	37.0	19.0	15.0	M27 x 2.0
	DCM-25S-MO33	25	46.0	41.0	38.0	41.0	19.0	17.0	M33 x 2.0
	DCM-30S-MO42	30	50.0	50.0	48.0	45.0	19.5	18.5	M42 x 2.0

- Dimensions and Drawings are for reference only and are subject to change without prior notice.
- Unless otherwise specified, all dimensions are in millimeters.
- Sizes, pressure classes, and end connections not listed are available upon request.
- Length given approximate figure with tightened nut.

DCM-GM (BSP Parallel)

Male Connector

BSP Parallel Thread Type

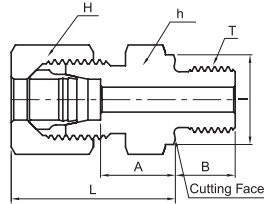
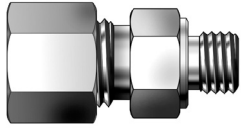

Series	Part No.	Tube O.D.	Dimension						
			H	h	I	L	A	B	T
L Light PN 315	DCM-06L-01GM	6	14.0	14.0	14.0	23.0	8.5	8.0	PF 1/8
	DCM-06L-02GM	6	14.0	19.0	18.0	25.0	10.0	12.0	PF 1/4
	DCM-06L-03GM	6	14.0	22.0	22.0	26.0	11.5	12.0	PF 3/8
	DCM-06L-04GM	6	14.0	27.0	26.0	27.0	12.0	14.0	PF 1/2
	DCM-08L-01GM	8	17.0	14.0	14.0	23.0	8.5	8.0	PF 1/8
	DCM-08L-02GM	8	17.0	19.0	18.0	25.0	10.0	12.0	PF 1/4
	DCM-08L-03GM	8	17.0	22.0	22.0	26.0	11.5	12.0	PF 3/8
	DCM-08L-04GM	8	17.0	27.0	26.0	27.0	12.0	14.0	PF 1/2
	DCM-10L-02GM	10	19.0	19.0	18.0	26.0	11.0	12.0	PF 1/4
	DCM-10L-03GM	10	19.0	22.0	22.0	27.0	12.5	12.0	PF 3/8
	DCM-10L-04GM	10	19.0	27.0	26.0	28.0	13.0	14.0	PF 1/2
	DCM-12L-02GM	12	22.0	19.0	18.0	27.0	12.0	12.0	PF 1/4
	DCM-12L-03GM	12	22.0	22.0	22.0	27.0	12.5	12.0	PF 3/8
	DCM-12L-04GM	12	22.0	27.0	26.0	28.0	13.0	14.0	PF 1/2
	DCM-12L-06GM	12	22.0	32.0	32.0	29.0	14.0	16.0	PF 3/4
	DCM-15L-03GM	15	27.0	24.0	22.0	29.0	13.5	12.0	PF 3/8
	DCM-15L-04GM	15	27.0	27.0	26.0	29.0	14.0	14.0	PF 1/2
	DCM-15L-06GM	15	27.0	32.0	32.0	30.0	15.0	16.0	PF 3/4
	DCM-18L-03GM	18	32.0	27.0	22.0	29.5	14.0	12.0	PF 3/8
	DCM-18L-04GM	18	32.0	27.0	26.0	31.0	14.5	14.0	PF 1/2
DCM-18L-06GM	18	32.0	32.0	32.0	30.0	14.5	16.0	PF 3/4	
PN 160	DCM-22L-04GM	22	36.0	32.0	26.0	33.0	16.5	14.0	PF 1/2
	DCM-22L-06GM	22	36.0	32.0	32.0	33.0	16.5	16.0	PF 3/4
	DCM-28L-06GM	28	41.0	41.0	32.0	34.0	17.5	16.0	PF 3/4
	DCM-28L-08GM	28	41.0	41.0	39.0	34.0	17.5	18.0	PF 1
	DCM-35L-08GM	35	50.0	46.0	39.0	39.0	17.5	18.0	PF 1
	DCM-35L-10GM	35	50.0	50.0	49.0	39.0	17.5	20.0	PF 1-1/4
DCM-42L-12GM	42	60.0	55.0	55.0	42.0	19.0	22.0	PF 1-1/2	
S Heavy PB 630	DCM-06S-02GM	6	17.0	19.0	18.0	28.0	13.0	12.0	PF 1/4
	DCM-06S-04GM	6	17.0	27.0	26.0	33.0	18.0	14.0	PF 1/2
	DCM-08S-02GM	8	19.0	19.0	18.0	30.0	15.0	12.0	PF 1/4
	DCM-08S-03GM	8	19.0	22.0	22.0	30.0	15.5	12.0	PF 3/8
	DCM-10S-02GM	10	22.0	19.0	18.0	31.0	14.5	12.0	PF 1/4
	DCM-10S-03GM	10	22.0	22.0	22.0	31.0	15.0	12.0	PF 3/8
	DCM-10S-04GM	10	22.0	27.0	26.0	34.0	17.5	14.0	PF 1/2
	DCM-12S-02GM	12	24.0	22.0	18.0	33.0	16.5	12.0	PF 1/4
	DCM-12S-03GM	12	24.0	22.0	22.0	33.0	17.0	12.0	PF 3/8
	DCM-12S-04GM	12	24.0	27.0	26.0	34.0	17.5	14.0	PF 1/2
PB 400	DCM-14S-03GM	14	27.0	24.0	22.0	36.0	18.5	12.0	PF 3/8
	DCM-14S-04GM	14	27.0	27.0	26.0	37.0	19.0	14.0	PF 1/2
	DCM-16S-03GM	16	30.0	27.0	22.0	36.0	18.0	12.0	PF 3/8
	DCM-16S-04GM	16	30.0	27.0	26.0	37.0	18.5	14.0	PF 1/2
	DCM-16S-06GM	16	30.0	32.0	32.0	39.0	20.5	16.0	PF 3/4
	DCM-20S-04GM	20	36.0	32.0	26.0	42.0	20.5	14.0	PF 1/2
PB 250	DCM-20S-06GM	20	36.0	32.0	32.0	42.0	20.5	16.0	PF 3/4
	DCM-25S-06GM	25	46.0	41.0	32.0	47.0	23.0	16.0	PF 3/4
	DCM-25S-08GM	25	46.0	41.0	39.0	47.0	23.0	18.0	PF 1
	DCM-30S-08GM	30	50.0	46.0	39.0	50.0	23.5	18.0	PF 1
PB 250	DCM-30S-10GM	30	50.0	50.0	49.0	50.0	23.5	20.0	PF 1-1/4
	DCM-38S-10GM	38	60.0	55.0	49.0	57.0	26.0	20.0	PF 1-1/4
	DCM-38S-12GM	38	60.0	55.0	55.0	57.0	26.0	22.0	PF 1-1/2

* ISO/BSP parallel gaskets are available. See the Last Page.

- Dimensions and Drawings are for reference only and are subject to change without prior notice.
- Unless otherwise specified, all dimensions are in millimeters.
- Sizes, pressure classes, and end connections not listed are available upon request.
- Length given approximate figure with tightened nut.

DCM-R (BSP Tapered)

Male Connector

BSP Tapered Thread Type

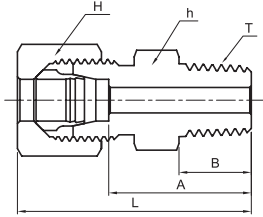
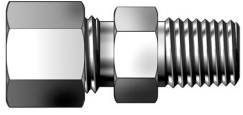

Series	Part No.	Tube O.D.	Dimension					
			H	h	L	A	B	T
LL Very Light PN 100	DCM-04LL-01R	4	10.0	11.0	26.0	16.0	8.0	PT 1/8
	DCM-06LL-01R	6	12.0	11.0	26.0	14.5	8.0	PT 1/8
	DCM-08LL-01R	8	14.0	12.0	28.0	16.5	8.0	PT 1/8
	DCM-08LL-02R	8	14.0	14.0	32.0	20.5	12.0	PT 1/4
	DCM-10LL-02R	10	17.0	14.0	32.0	20.5	12.0	PT 1/4
	DCM-12LL-02R	12	19.0	17.0	32.0	20.0	12.0	PT 1/4
L Light PN 315	DCM-12LL-03R	12	19.0	17.0	32.0	20.0	12.0	PT 3/8
	DCM-06L-01R	6	14.0	12.0	30.0	15.0	8.0	PT 1/8
	DCM-08L-02R	8	17.0	17.0	35.0	20.0	12.0	PT 1/4
	DCM-10L-02R	10	19.0	17.0	36.0	21.0	12.0	PT 1/4
	DCM-12L-02R	12	22.0	19.0	37.0	22.0	12.0	PT 1/4
	DCM-12L-03R	12	22.0	19.0	37.0	22.0	12.0	PT 3/8
	DCM-12L-04R	12	22.0	24.0	39.0	24.0	14.0	PT 1/2
	DCM-15L-03R	15	27.0	24.0	38.0	23.0	12.0	PT 3/8
PN 160	DCM-15L-04R	15	27.0	24.0	40.0	25.0	14.0	PT 1/2
	DCM-18L-04R	18	32.0	27.0	41.0	25.5	14.0	PT 1/2
PN 160	DCM-22L-06R	22	36.0	32.0	46.0	29.5	16.0	PT 3/4

- Dimensions and Drawings are for reference only and are subject to change without prior notice.
- Unless otherwise specified, all dimensions are in millimeters.
- Sizes, pressure classes, and end connections not listed are available upon request.
- Length given approximate figure with tightened nut.

DCM-M (Metric Parallel)

Male Connector

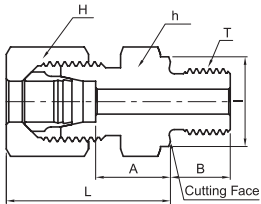
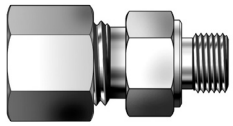

Metric Parallel Thread Type

Series	Part No.	Tube O.D.	Dimension						
			H	h	I	L	A	B	T
L Light PN 315	DCM-06L-M10M	6	14.0	14.0	14.0	23.0	8.5	8.0	M10 x 1.0
	DCM-08L-M12M	8	17.0	17.0	17.0	25.0	10.0	12.0	M12 x 1.5
	DCM-08L-M18M	8	17.0	24.0	23.0	26.0	11.5	12.0	M18 x 1.5
	DCM-10L-M14M	10	19.0	19.0	19.0	26.0	11.0	12.0	M14 x 1.5
	DCM-10L-M16M	10	19.0	22.0	21.0	27.0	12.0	12.0	M16 x 1.5
	DCM-10L-M18M	10	19.0	24.0	23.0	27.0	12.5	12.0	M18 x 1.5
	DCM-10L-M22M	10	19.0	27.0	27.0	29.0	14.0	14.0	M22 x 1.5
	DCM-12L-M14M	12	22.0	19.0	19.0	26.0	11.0	12.0	M14 x 1.5
	DCM-12L-M16M	12	22.0	22.0	21.0	27.0	12.5	12.0	M16 x 1.5
	DCM-12L-M18M	12	22.0	24.0	23.0	27.0	12.5	12.0	M18 x 1.5
	DCM-12L-M22M	12	22.0	27.0	27.0	29.0	14.0	14.0	M22 x 1.5
	DCM-15L-M16M	15	27.0	24.0	21.0	28.0	13.0	12.0	M16 x 1.5
	DCM-15L-M18M	15	27.0	24.0	23.0	29.0	13.5	12.0	M18 x 1.5
	DCM-15L-M22M	15	27.0	27.0	27.0	30.0	15.0	14.0	M22 x 1.5
	DCM-18L-M18M	18	32.0	27.0	23.0	30.0	14.0	12.0	M18 x 1.5
DCM-18L-M22M	18	32.0	27.0	27.0	31.0	14.5	14.0	M22 x 1.5	
PN 160	DCM-22L-M22M	22	36.0	32.0	27.0	33.0	16.5	14.0	M22 x 1.5
	DCM-22L-M26M	22	36.0	32.0	31.0	33.0	16.5	16.0	M26 x 1.5
	DCM-28L-M33M	28	41.0	41.0	39.0	34.0	17.5	18.0	M33 x 2.0
	DCM-35L-M42M	35	50.0	50.0	49.0	39.0	17.5	20.0	M42 x 2.0
	DCM-42L-M48M	42	60.0	55.0	55.0	42.0	19.0	22.0	M48 x 2.0
S Heavy PB 630	DCM-06S-M12M	6	17.0	17.0	17.0	28.0	13.0	12.0	M12 x 1.5
	DCM-08S-M14M	8	19.0	19.0	19.0	30.0	15.0	12.0	M14 x 1.5
	DCM-10S-M16M	10	22.0	22.0	21.0	31.0	15.0	12.0	M16 x 1.5
	DCM-12S-M18M	12	24.0	24.0	23.0	33.0	17.0	12.0	M18 x 1.5
	DCM-12S-M22M	12	24.0	27.0	27.0	34.0	17.5	14.0	M22 x 1.5
DCM-14S-M20M	14	27.0	27.0	25.0	37.0	19.0	14.0	M20 x 1.5	
PB 400	DCM-16S-M18M	16	30.0	27.0	23.0	36.0	18.0	12.0	M18 x 1.5
	DCM-16S-M22M	16	30.0	27.0	27.0	37.0	18.5	14.0	M22 x 1.5
	DCM-20S-M27M	20	36.0	32.0	32.0	42.0	20.5	16.0	M27 x 2.0
	DCM-25S-M33M	25	46.0	41.0	39.0	47.0	23.0	18.0	M33 x 2.0
PB 250	DCM-30S-M42M	30	50.0	50.0	49.0	50.0	23.5	20.0	M42 x 2.0
	DCM-38S-M48M	38	60.0	55.0	55.0	57.0	26.0	22.0	M48 x 2.0

DCM-MK (Metric Tapered)

Male Connector

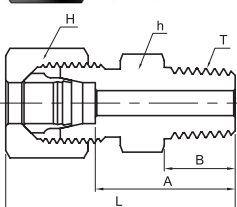
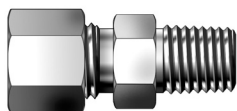

Metric Tapered Thread Type

Series	Part No.	Tube O.D.	Dimension						
			H	h	L	A	B	T	
LL Very Light PN 100	DCM-04LL-M06K	4	10	9	26	16	8	M6 x 1keg	
	DCM-04LL-M08K	4	10	10	26	16	8	M8 x 1keg	
	DCM-06LL-M10K	6	12	11	26	14.5	8	M10 x 1keg	
	DCM-08LL-M10K	8	14	12	28	16.5	8	M10 x 1keg	

- Dimensions and Drawings are for reference only and are subject to change without prior notice.
- Unless otherwise specified, all dimensions are in millimeters.
- Sizes, pressure classes, and end connections not listed are available upon request.
- Length given approximate figure with tightened nut.

DCM-GED (BSP Parallel with ED-Ring)

Male Connector with ED-Ring

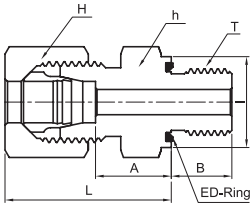
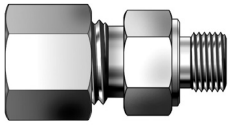

BSP Parallel Thread Type

Series	Part No.	Tube O.D.	Dimension						
			H	h	I	L	A	B	T
L Light PN 315	DCM-06L-01GED	6	14.0	14.0	14.0	23.0	8.5	8.0	PF 1/8
	DCM-06L-02GED	6	14.0	19.0	19.0	25.0	10.0	12.0	PF 1/4
	DCM-08L-01GED	8	17.0	14.0	14.0	24.0	9.5	8.0	PF 1/8
	DCM-08L-02GED	8	17.0	19.0	19.0	25.0	10.0	12.0	PF 1/4
	DCM-08L-03GED	8	17.0	22.0	22.0	26.0	11.5	12.0	PF 3/8
	DCM-10L-02GED	10	19.0	19.0	19.0	26.0	11.0	12.0	PF 1/4
	DCM-10L-03GED	10	19.0	22.0	22.0	27.0	12.5	12.0	PF 3/8
	DCM-10L-04GED	10	19.0	27.0	27.0	28.0	13.0	14.0	PF 1/2
	DCM-12L-03GED	12	22.0	19.0	19.0	27.0	12.0	12.0	PF 1/4
	DCM-12L-04GED	12	22.0	27.0	27.0	28.0	13.0	14.0	PF 1/2
	DCM-15L-03GED	15	27.0	24.0	22.0	29.0	13.5	12.0	PF 3/8
	DCM-15L-04GED	15	27.0	27.0	27.0	29.0	14.0	14.0	PF 1/2
	DCM-18L-04GED	18	32.0	27.0	27.0	31.0	14.5	14.0	PF 1/2
	DCM-18L-06GED	18	32.0	32.0	32.0	31.0	14.5	16.0	PF 3/4
PN 160	DCM-22L-06GED	22	36.0	32.0	32.0	33.0	16.5	16.0	PF 3/4
	DCM-28L-08GED	28	41.0	41.0	40.0	34.0	17.5	18.0	PF 1
	DCM-35L-10GED	35	50.0	50.0	50.0	39.0	17.5	20.0	PF 1-1/4
	DCM-42L-12GED	42	60.0	55.0	55.0	42.0	19.0	22.0	PF 1-1/2
S Heavy PB 630	DCM-06S-02GED	6	17.0	19.0	19.0	28.0	13.0	12.0	PF 1/4
	DCM-08S-02GED	8	19.0	19.0	19.0	30.0	15.0	12.0	PF 1/4
	DCM-08S-03GED	8	19.0	22.0	22.0	30.0	15.5	12.0	PF 3/8
	DCM-10S-02GED	10	22.0	19.0	19.0	31.0	14.5	12.0	PF 1/4
	DCM-10S-03GED	10	22.0	22.0	22.0	31.0	15.0	12.0	PF 3/8
	DCM-10S-04GED	10	22.0	27.0	27.0	34.0	17.5	14.0	PF 1/2
	DCM-12S-02GED	12	24.0	22.0	19.0	33.0	16.5	12.0	PF 1/4
	DCM-12S-03GED	12	24.0	22.0	22.0	33.0	17.0	12.0	PF 3/8
DCM-12S-04GED	12	24.0	27.0	32.0	34.0	17.5	14.0	PF 1/2	
DCM-14S-04GED	14	27.0	27.0	27.0	37.0	19.0	14.0	PF 1/2	
PN 400	DCM-16S-03GED	16	30.0	27.0	22.0	36.0	18.0	12.0	PF 3/8
	DCM-16S-04GED	16	30.0	27.0	27.0	37.0	18.5	14.0	PF 1/2
	DCM-16S-06GED	16	30.0	32.0	27.0	39.0	20.5	16.0	PF 3/4
	DCM-20S-06GED	20	36.0	32.0	32.0	42.0	20.5	16.0	PF 3/4
	DCM-25S-04GED	25	46.0	41.0	27.0	47.0	23.0	14.0	PF 1/2
	DCM-25S-06GED	25	46.0	41.0	32.0	47.0	23.0	16.0	PF 3/4
DCM-25S-08GED	25	46.0	41.0	40.0	47.0	23.0	18.0	PF 1	
DCM-30S-10GED	30	50.0	50.0	50.0	50.0	23.5	20.0	PF 1-1/4	
PN 315	DCM-38S-12GED	38	60.0	55.0	55.0	57.0	26.0	22.0	PF 1-1/2

- Dimensions and Drawings are for reference only and are subject to change without prior notice.
- Unless otherwise specified, all dimensions are in millimeters.
- Sizes, pressure classes, and end connections not listed are available upon request.
- Length given approximate figure with tightened nut.

DCM-MED (Metric Parallel with ED-Ring)

Male Connector with ED-Ring

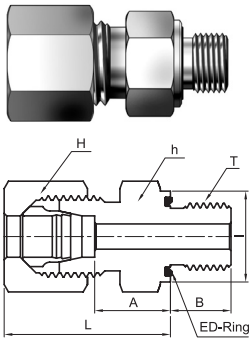

Metric Parallel Thread Type

Series	Part No.	Tube O.D.	Dimension						
			H	h	I	L	A	B	T
L Light PN315	DCM-06L-M10ED	6	14.0	14.0	14.0	23.0	8.5	8.0	M10 x 1.0
	DCM-08L-M12ED	8	17.0	17.0	17.0	25.0	10.0	12.0	M12 x 1.5
	DCM-10L-M14ED	10	19.0	19.0	19.0	26.0	11.0	12.0	M14 x 1.5
	DCM-12L-M16ED	12	22.0	22.0	22.0	27.0	12.5	12.0	M16 x 1.5
	DCM-12L-M18ED	12	22.0	24.0	24.0	27.0	12.5	12.0	M18 x 1.5
	DCM-12L-M22ED	12	22.0	27.0	27.0	29.0	14.0	14.0	M22 x 1.5
	DCM-15L-M18ED	15	27.0	24.0	24.0	29.0	13.5	12.0	M18 x 1.5
	DCM-15L-M22ED	15	27.0	27.0	27.0	30.0	15.0	14.0	M22 x 1.5
	DCM-18L-M22ED	18	32.0	27.0	27.0	31.0	14.5	14.0	M22 x 1.5
	PN 160	DCM-22L-M26ED	22	36.0	32.0	32.0	33.0	16.5	16.0
DCM-28L-M33ED		28	41.0	41.0	40.0	34.0	17.5	18.0	M33 x 2.0
DCM-35L-M42ED		35	50.0	50.0	50.0	39.0	17.5	20.0	M42 x 2.0
DCM-42L-M48ED		42	60.0	55.0	55.0	42.0	19.0	22.0	M48 x 2.0
S Heavy PB 630	DCM-06S-M12ED	6	17.0	17.0	17.0	28.0	13.0	12.0	M12 x 1.5
	DCM-08S-M14ED	8	19.0	19.0	19.0	30.0	15.0	12.0	M14 x 1.5
	DCM-10S-M16ED	10	22.0	22.0	22.0	31.0	15.0	12.0	M16 x 1.5
	DCM-12S-M18ED	12	24.0	24.0	24.0	33.0	17.0	12.0	M18 x 1.5
	DCM-14S-M20ED	14	27.0	27.0	26.0	37.0	19.0	14.0	M20 x 1.5
PN 400	DCM-16S-M22ED	16	30.0	27.0	27.0	37.0	18.5	14.0	M22 x 1.5
	DCM-20S-M27ED	20	36.0	32.0	32.0	42.0	20.5	16.0	M27 x 2.0
	DCM-25S-M33ED	25	46.0	41.0	40.0	47.0	23.0	18.0	M33 x 2.0
PN 315	DCM-30S-M42ED	30	50.0	50.0	50.0	50.0	23.5	20.0	M42 x 2.0
	DCM-38S-M48ED	38	60.0	55.0	55.0	57.0	26.0	22.0	M48 x 2.0

- Dimensions and Drawings are for reference only and are subject to change without prior notice.
- Unless otherwise specified, all dimensions are in millimeters.
- Sizes, pressure classes, and end connections not listed are available upon request.
- Length given approximate figure with tightened nut.

DCM-N (NPT Thread)

Male Connector

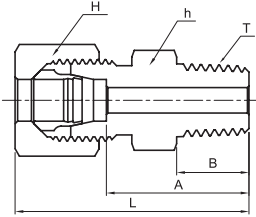
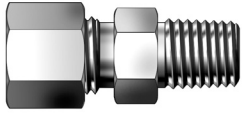

NPT Thread Type

Series	Part No.	Tube O.D.	Dimension					
			H	h	L	A	B	T
LL	DCM-04LL-01N	4	10.0	11.0	28.0	18.5	9.9	NPT 1/8
Very Light	DCM-06LL-01N	6	12.0	11.0	28.0	16.5	9.9	NPT 1/8
	PN 100	DCM-08LL-01N	8	14.0	12.0	30.0	18.5	9.9
L Light PN 315	DCM-06L-01N	6	14.0	12.0	32.0	17.0	9.9	NPT 1/8
	DCM-06L-02N	6	14.0	17.0	38.0	23.0	14.2	NPT 1/4
	DCM-08L-02N	8	17.0	17.0	38.0	23.0	14.2	NPT 1/4
	DCM-10L-02N	10	19.0	17.0	39.0	24.0	14.2	NPT 1/4
	DCM-10L-03N	10	19.0	19.0	40.0	25.0	14.2	NPT 3/8
	DCM-12L-02N	12	22.0	19.0	40.0	25.0	14.2	NPT 1/4
	DCM-12L-03N	12	22.0	19.0	40.0	25.0	14.2	NPT 3/8
	DCM-12L-04N	12	22.0	22.0	45.0	30.0	19.1	NPT 1/2
PN 160	DCM-15L-04N	15	27.0	24.0	46.0	31.0	19.1	NPT 1/2
	DCM-18L-04N	18	32.0	27.0	48.0	31.5	19.1	NPT 1/2
	DCM-22L-06N	22	36.0	32.0	50.0	33.5	19.1	NPT 3/4
	DCM-28L-08N	28	41.0	41.0	56.0	39.5	23.9	NPT 1
S Heavy PN 630	DCM-35L-10N	35	50.0	46.0	62.0	40.5	23.9	NPT 1-1/4
	DCM-42L-12N	42	60.0	55.0	65.0	42.0	25.4	NPT 1-1/2
	DCM-06S-02N	6	17.0	17.0	43.0	28.0	14.2	NPT 1/4
	DCM-08S-02N	8	19.0	17.0	43.0	28.0	14.2	NPT 1/4
	DCM-10S-02N	10	22.0	19.0	44.0	27.5	14.2	NPT 1/4
	DCM-10S-03N	10	22.0	19.0	44.0	27.5	14.2	NPT 3/8
	DCM-12S-02N	12	24.0	22.0	46.0	29.5	14.2	NPT 1/4
	DCM-12S-03N	12	24.0	22.0	46.0	29.5	14.2	NPT 3/8
PN 400	DCM-12S-04N	12	24.0	22.0	51.0	34.5	19.1	NPT 1/2
	DCM-14S-04N	14	27.0	24.0	54.0	36.0	19.1	NPT 1/2
	DCM-16S-04N	16	30.0	27.0	54.0	35.5	19.1	NPT 1/2
	DCM-20S-06N	20	36.0	32.0	59.0	37.5	19.1	NPT 3/4
PN 315	DCM-25S-08N	25	46.0	41.0	69.0	45.0	23.9	NPT 1
	DCM-30S-10N	30	50.0	46.0	73.0	46.5	23.9	NPT 1-1/4
PN 315	DCM-38S-12N	38	60.0	55.0	80.0	49.0	25.4	NPT 1-1/2

- Dimensions and Drawings are for reference only and are subject to change without prior notice.
- Unless otherwise specified, all dimensions are in millimeters.
- Sizes, pressure classes, and end connections not listed are available upon request.
- Length given approximate figure with tightened nut.

DME-R/MK (BSP Tapered/Metric Tapered)

Male Elbow

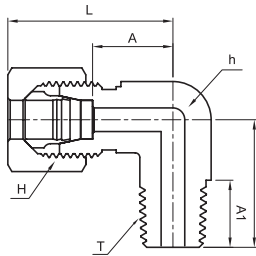
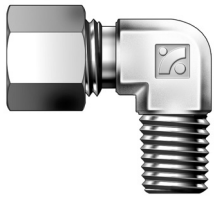

BSP Tapered Thread Type

Series	Part No.	Tube O.D.	Dimension						
			H	h	L	L1	A	A1	T
LL Very Light PN 100	DME-04LL-01R	4.0	10.0	9.0	21.0	17.0	11.0	10.0	PT 1/8
	DME-06LL-01R	6.0	12.0	9.0	21.0	17.0	9.5	10.0	PT 1/8
	DME-08LL-01R	8.0	14.0	12.0	23.0	20.0	11.5	10.0	PT 1/8
	DME-10LL-02R	10.0	17.0	14.0	24.0	23.0	12.5	14.0	PT 1/4
	DME-12LL-02R	12.0	19.0	17.0	25.0	23.0	13.0	14.0	PT 1/4
L Light PN 315	DME-06L-01R	6.0	14.0	12.0	27.0	20.0	12.0	10.0	PT 1/8
	DME-08L-02R	8.0	17.0	12.0	29.0	26.0	14.0	14.0	PT 1/4
	DME-10L-02R	10.0	19.0	14.0	30.0	27.0	15.0	14.0	PT 1/4
	DME-12L-03R	12.0	22.0	17.0	32.0	28.0	17.0	15.0	PT 3/8
	DME-15L-04R	15.0	27.0	19.0	36.0	34.0	21.0	19.0	PT 1/2
	DME-18L-04R	18.0	32.0	24.0	40.0	36.0	23.5	19.0	PT 1/2
S Heavy PN 400	DME-06S-02R	6.0	17.0	12.0	31.0	26.0	16.0	14.0	PT 1/4
	DME-08S-02R	8.0	19.0	14.0	32.0	27.0	17.0	14.0	PT 1/4
	DME-10S-03R	10.0	22.0	17.0	34.0	28.0	17.5	15.0	PT 3/8
	DME-12S-03R	12.0	24.0	17.0	38.0	28.0	21.5	15.0	PT 3/8
	DME-14S-04R	14.0	27.0	19.0	40.0	34.0	22.0	19.0	PT 1/2
DME-16S-04R	16.0	30.0	24.0	43.0	36.0	24.5	19.0	PT 1/2	

Metric Tapered Thread Type

Series	Part No.	Tube O.D.	Dimension						
			H	h	L	L1	A	A1	T
LL Very Light PN 100	DME-04LL-M08K	4	10.0	9.0	21.0	17.0	11.0	8.0	M8 x 1.0Keg
	DME-06LL-M10K	6	12.0	9.0	21.0	17.0	9.5	8.0	M10 x 1.0Keg
	DME-08LL-M10K	8	14.0	12.0	23.0	20.0	11.5	8.0	M10 x 1.0Keg
L Light PN 315	DME-06L-M10K	6	14.0	12.0	27.0	20.0	12.0	8.0	M10 x 1.0Keg
	DME-08L-M12K	8	17.0	12.0	29.0	26.0	14.0	12.0	M12 x 1.5Keg
	DME-10L-M14K	10	19.0	14.0	30.0	27.0	15.0	12.0	M14 x 1.5Keg
	DME-12L-M16K	12	22.0	17.0	32.0	28.0	17.0	14.0	M16 x 1.5Keg
	DME-15L-M18K	15	27.0	19.0	36.0	34.0	21.0	14.0	M18 x 1.5Keg
	DME-18L-M22K	18	32.0	24.0	40.0	36.0	23.5	17.0	M22 x 1.5Keg
S Heavy PN 400	DME-06S-M12K	6	17.0	12.0	31.0	26.0	16.0	12.0	M12 x 1.5Keg
	DME-08S-M14K	8	19.0	14.0	32.0	27.0	17.0	12.0	M14 x 1.5Keg
	DME-10S-M16K	10	22.0	17.0	34.0	28.0	17.5	12.0	M16 x 1.5Keg
	DME-12S-M18K	12	24.0	17.0	38.0	28.0	21.5	12.0	M18 x 1.5Keg
	DME-14S-M20K	14	27.0	19.0	40.0	32.0	22.0	14.0	M20 x 1.5Keg
DME-16S-M22K	16	30.0	24.0	43.0	32.0	24.5	17.0	M22 x 1.5Keg	

- Dimensions and Drawings are for reference only and are subject to change without prior notice.
- Unless otherwise specified, all dimensions are in millimeters.
- Sizes, pressure classes, and end connections not listed are available upon request.
- Length given approximate figure with tightened nut.

DCF-G/M (BSP Parallel/Metric Parallel)

Female Connector

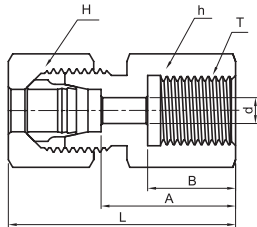
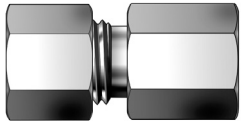

BSP Parallel Thread Type

Series	Part No.	Tube O.D.	Dimension						
			d	H	h	L	A	B	T
L Light PN 315	DCF-06L-01G	6	4.0	14.0	14.0	34.0	19.0	12.0	PF 1/8
	DCF-08L-02G	8	6.0	17.0	19.0	39.0	24.0	17.0	PF 1/4
	DCF-08L-03G	8	6.0	17.0	24.0	40.0	25.0	17.0	PF 3/8
	DCF-08L-04G	8	6.0	17.0	27.0	44.0	29.0	20.0	PF 1/2
	DCF-10L-02G	10	8.0	19.0	19.0	40.0	25.0	17.0	PF 1/4
	DCF-10L-03G	10	8.0	19.0	24.0	41.0	26.0	17.0	PF 3/8
	DCF-10L-04G	10	8.0	19.0	27.0	45.0	30.0	20.0	PF 1/2
	DCF-12L-03G	12	10.0	22.0	24.0	41.0	26.0	17.0	PF 3/8
	DCF-12L-04G	12	10.0	22.0	27.0	45.0	30.0	20.0	PF 1/2
	DCF-15L-04G	15	12.0	27.0	27.0	46.0	31.0	20.0	PF 1/2
	DCF-18L-04G	18	15.0	32.0	27.0	47.0	30.5	20.0	PF 1/2
	PB 160	DCF-22L-06G	22	19.0	36.0	36.0	52.0	35.5	22.0
DCF-28L-08G		28	24.0	41.0	41.0	55.0	38.0	24.5	PF 1
DCF-35L-10G		35	30.0	50.0	55.0	63.0	41.0	26.5	PF 1-1/4
DCF-42L-12G		42	36.0	60.0	60.0	65.0	42.5	28.5	PF 1-1/2
S Heavy PB 630	DCF-06S-02G	6	4.0	17.0	19.0	41.0	26.0	17.0	PF 1/4
	DCF-08S-02G	8	5.0	19.0	19.0	41.0	26.0	17.0	PF 1/4
	DCF-10S-03G	10	7.0	22.0	24.0	43.0	26.5	17.0	PF 3/8
	DCF-12S-03G	12	8.0	24.0	24.0	43.0	26.5	17.0	PF 3/8
	DCF-14S-04G	14	10.0	27.0	30.0	50.0	32.0	20.0	PF 1/2
PB 400	DCF-16S-04G	16	12.0	30.0	30.0	50.0	31.5	20.0	PF 1/2
	DCF-20S-06G	20	16.0	36.0	36.0	56.0	34.5	22.0	PF 3/4
	DCF-25S-08G	25	20.0	46.0	41.0	62.0	37.5	24.5	PF 1
	DCF-30S-10G	30	25.0	50.0	55.0	69.0	42.0	26.5	PF 1-1/4
PB 315	DCF-38S-12G	38	32.0	60.0	60.0	74.0	43.5	28.5	PF 1-1/2

Metric Parallel Thread Type

Series	Part No.	Tube O.D.	Dimension						
			d	H	h	L	A	B	T
L Light PB 315	DCF-06L-M10	6	4.0	14.0	14.0	34.0	19.5	12.5	M10 x 1.0
	DCF-08L-M12	8	6.0	17.0	17.0	39.0	24.0	17.0	M12 x 1.5
	DCF-10L-M14	10	8.0	19.0	19.0	40.0	25.0	17.0	M14 x 1.5
	DCF-12L-M16	12	10.0	22.0	22.0	41.0	26.0	17.0	M16 x 1.5
	DCF-15L-M18	15	12.0	27.0	24.0	43.0	28.0	17.0	M18 x 1.5
	DCF-18L-M22	18	15.0	32.0	30.0	46.0	29.5	19.0	M22 x 1.5
PB 160	DCF-22L-M26	22	19.0	36.0	32.0	51.0	34.5	21.0	M26 x 1.5
	DCF-28L-M33	28	24.0	41.0	41.0	54.0	37.5	24.0	M33 x 2.0
	DCF-35L-M42	35	30.0	50.0	55.0	62.0	40.5	26.0	M42 x 2.0
	DCF-42L-M48	42	36.0	60.0	60.0	65.0	42.0	28.0	M48 x 2.0
S Heavy PB 630	DCF-06S-M12	6	4.0	17.0	17.0	41.0	26.0	17.0	M12 x 1.5
	DCF-08S-M14	8	5.0	19.0	19.0	41.0	26.0	17.0	M14 x 1.5
	DCF-10S-M16	10	7.0	22.0	22.0	43.0	26.5	17.0	M16 x 1.5
	DCF-12S-M18	12	8.0	24.0	24.0	44.0	27.5	17.0	M18 x 1.5
	DCF-14S-M20	14	10.0	27.0	27.0	49.0	31.0	19.0	M20 x 1.5
PB 400	DCF-16S-M22	16	12.0	30.0	30.0	49.0	30.5	19.0	M22 x 1.5
	DCF-20S-M27	20	16.0	36.0	36.0	56.0	34.5	22.0	M27 x 2.0
	DCF-25S-M33	25	20.0	46.0	41.0	61.0	37.0	24.0	M33 x 2.0
	DCF-30S-M42	30	25.0	50.0	55.0	68.0	41.5	26.0	M42 x 2.0
PB 315	DCF-38S-M48	38	32.0	60.0	60.0	74.0	43.0	28.0	M48 x 2.0

- Dimensions and Drawings are for reference only and are subject to change without prior notice.
- Unless otherwise specified, all dimensions are in millimeters.
- Sizes, pressure classes, and end connections not listed are available upon request.
- Length given approximate figure with tightened nut.

DAE

Adjustable Elbow

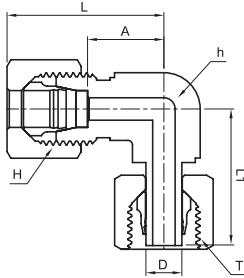
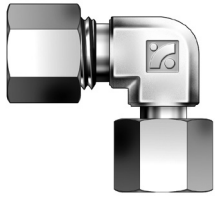

Series	Part No.	Tube O.D.	Dimension						
			D	H	h	L	L1	A	T
L Light PN 315	DAE-06L	6	6	14.0	12.0	27.0	26.0	12.0	M12 x 1.5
	DAE-08L	8	8	17.0	12.0	29.0	27.5	14.0	M14 x 1.5
	DAE-10L	10	10	19.0	14.0	30.0	29.0	15.0	M16 x 1.5
	DAE-12L	12	12	22.0	17.0	32.0	29.5	17.0	M18 x 1.5
	DAE-15L	15	15	27.0	19.0	36.0	32.5	21.0	M22 x 1.5
	DAE-18L	18	18	32.0	24.0	40.0	35.5	23.5	M26 x 1.5
PN 160	DAE-22L	22	22	36.0	27.0	44.0	38.5	27.5	M30 x 2.0
	DAE-28L	28	28	41.0	36.0	47.0	41.5	30.5	M36 x 2.0
	DAE-35L	35	35	50.0	41.0	56.0	51.0	34.5	M45 x 2.0
	DAE-42L	42	42	60.0	50.0	63.0	56.0	40.0	M52 x 2.0
S Heavy PN 630	DAE-06S	6	6	17.0	12.0	31.0	27.0	16.0	M14 x 1.5
	DAE-08S	8	8	19.0	14.0	32.0	27.5	17.0	M16 x 1.5
	DAE-10S	10	10	22.0	17.0	34.0	30.0	17.5	M18 x 1.5
	DAE-12S	12	12	24.0	17.0	38.0	31.0	21.5	M20 x 1.5
	DAE-14S	14	14	27.0	19.0	40.0	35.0	22.0	M22 x 1.5
PN 400	DAE-16S	16	16	30.0	24.0	43.0	40.0	24.5	M24 x 1.5
	DAE-20S	20	20	36.0	27.0	48.0	44.5	26.5	M30 x 2.0
	DAE-25S	25	25	46.0	36.0	54.0	50.0	30.0	M36 x 2.0
PN 315	DAE-30S	30	30	50.0	41.0	62.0	55.0	35.5	M42 x 2.0
	DAE-38S	38	38	60.0	50.0	72.0	63.0	41.0	M52 x 2.0

DABT

Adjustable Branch Tee

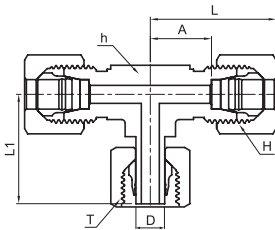
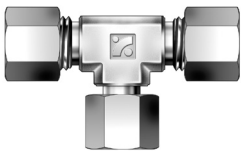

Series	Part No.	Tube O.D.	Dimension						
			D	H	h	L	L1	A	T
L Light PN 315	DABT-06L	6	6	14.0	12.0	27.0	26.0	12.0	M12 x 1.5
	DABT-08L	8	8	17.0	12.0	29.0	27.5	14.0	M14 x 1.5
	DABT-10L	10	10	19.0	14.0	30.0	29.0	15.0	M16 x 1.5
	DABT-12L	12	12	22.0	17.0	32.0	29.5	17.0	M18 x 1.5
	DABT-15L	15	15	27.0	19.0	36.0	32.5	21.0	M22 x 1.5
	DABT-18L	18	18	32.0	24.0	40.0	35.5	23.5	M26 x 1.5
PN 160	DABT-22L	22	22	36.0	27.0	44.0	38.5	27.5	M30 x 2.0
	DABT-28L	28	28	41.0	36.0	47.0	41.5	30.5	M36 x 2.0
	DABT-35L	35	35	50.0	41.0	56.0	51.0	34.5	M45 x 2.0
	DABT-42L	42	42	60.0	50.0	63.0	56.0	40.0	M52 x 2.0
S Heavy PN 630	DABT-06S	6	6	17.0	12.0	31.0	27.0	16.0	M14 x 1.5
	DABT-08S	8	8	19.0	14.0	32.0	27.5	17.0	M16 x 1.5
	DABT-10S	10	10	22.0	17.0	34.0	30.0	17.5	M18 x 1.5
	DABT-12S	12	12	24.0	17.0	38.0	31.0	21.5	M20 x 1.5
	DABT-14S	14	14	27.0	19.0	40.0	35.0	22.0	M22 x 1.5
PN 400	DABT-16S	16	16	30.0	24.0	43.0	40.0	24.5	M24 x 1.5
	DABT-20S	20	20	36.0	27.0	48.0	44.5	26.5	M30 x 2.0
	DABT-25S	25	25	46.0	36.0	54.0	50.0	30.0	M36 x 2.0
PN 315	DABT-30S	30	30	50.0	41.0	62.0	55.0	35.5	M42 x 2.0
	DABT-38S	38	38	60.0	50.0	72.0	63.0	41.0	M52 x 2.0

- Dimensions and Drawings are for reference only and are subject to change without prior notice.
- Unless otherwise specified, all dimensions are in millimeters.
- Sizes, pressure classes, and end connections not listed are available upon request.
- Length given approximate figure with tightened nut.

DART

Adjustable Run Tee

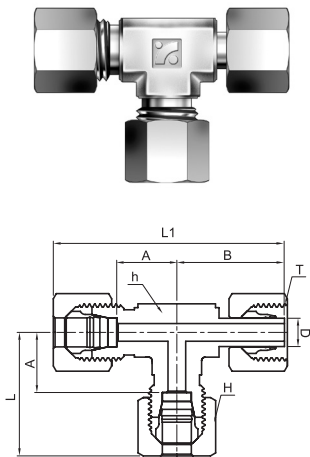

Series	Part No.	Tube O.D.	Dimension							
			D	H	h	L	L1	A	B	T
L Light PN 315	DART -06L	6	6	14.0	12.0	27.0	53.0	12.0	26.0	M12 x 1.5
	DART -08L	8	8	17.0	12.0	29.0	56.0	14.0	27.5	M14 x 1.5
	DART -10L	10	10	19.0	14.0	30.0	59.0	15.0	29.0	M16 x 1.5
	DART -12L	12	12	22.0	17.0	32.0	62.0	17.0	29.5	M18 x 1.5
	DART -15L	15	15	27.0	19.0	36.0	69.0	21.0	32.5	M22 x 1.5
	DART -18L	18	18	32.0	24.0	40.0	75.0	23.5	35.5	M26 x 1.5
PN 160	DART -22L	22	22	36.0	27.0	44.0	83.0	27.5	38.5	M30 x 2.0
	DART -28L	28	28	41.0	36.0	47.0	91.0	30.5	41.5	M36 x 2.0
	DART -35L	35	35	50.0	41.0	56.0	111.0	34.5	51.0	M45 x 2.0
	DART -42L	42	42	60.0	50.0	63.0	123.0	40.0	56.0	M52 x 2.0
S Heavy PN 630	DART -06S	6	6	17.0	12.0	31.0	58.0	16.0	27.0	M14 x 1.5
	DART -08S	8	8	19.0	14.0	32.0	61.0	17.0	27.5	M16 x 1.5
	DART -10S	10	10	22.0	17.0	34.0	66.0	17.5	30.0	M18 x 1.5
	DART -12S	12	12	24.0	17.0	38.0	71.0	21.5	31.0	M20 x 1.5
	DART -14S	14	14	27.0	19.0	40.0	75.0	22.0	35.0	M22 x 1.5
PN 400	DART -16S	16	16	30.0	24.0	43.0	79.0	24.5	40.0	M24 x 1.5
	DART -20S	20	20	36.0	27.0	48.0	93.0	26.5	44.5	M30 x 2.0
	DART -25S	25	25	46.0	36.0	54.0	105.0	30.0	50.0	M36 x 2.0
PN 315	DART -30S	30	30	50.0	41.0	62.0	119.0	35.5	55.0	M42 x 2.0
	DART -38S	38	38	60.0	50.0	72.0	138.0	41.0	63.0	M52 x 2.0

DSE

Swivel Adjustable Elbow

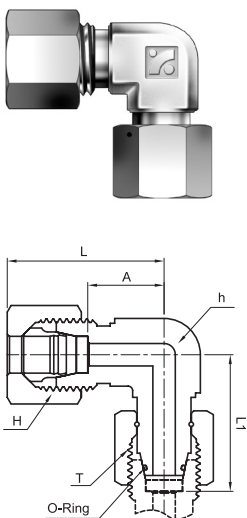

Series	Part No.	Tube O.D.	Dimension					
			H	h	L	L1	A	T
L Light PN 315	DSE -06L	6	14.0	12.0	27.0	26.0	12.0	M12 x 1.5
	DSE -08L	8	17.0	12.0	29.0	27.5	14.0	M14 x 1.5
	DSE -10L	10	19.0	14.0	30.0	29.0	15.0	M16 x 1.5
	DSE -12L	12	22.0	17.0	32.0	29.5	17.0	M18 x 1.5
	DSE -15L	15	27.0	19.0	36.0	32.5	21.0	M22 x 1.5
	DSE -18L	18	32.0	24.0	40.0	35.5	23.5	M26 x 1.5
PN 160	DSE -22L	22	36.0	27.0	44.0	38.5	27.5	M30 x 2.0
	DSE -28L	28	41.0	36.0	47.0	41.5	30.5	M36 x 2.0
	DSE -35L	35	50.0	41.0	56.0	51.0	34.5	M45 x 2.0
	DSE -42L	42	60.0	50.0	63.0	56.0	40.0	M52 x 2.0
S Heavy PN 630	DSE -06S	6	17.0	12.0	31.0	27.0	16.0	M14 x 1.5
	DSE -08S	8	19.0	14.0	32.0	27.5	17.0	M16 x 1.5
	DSE -10S	10	22.0	17.0	34.0	30.0	17.5	M18 x 1.5
	DSE -12S	12	24.0	17.0	38.0	31.0	21.5	M20 x 1.5
	DSE -14S	14	27.0	19.0	40.0	35.0	22.0	M22 x 1.5
PN 400	DSE -16S	16	30.0	24.0	43.0	36.5	24.5	M24 x 1.5
	DSE -20S	20	36.0	27.0	48.0	44.5	26.5	M30 x 2.0
	DSE -25S	25	46.0	36.0	54.0	50.0	30.0	M36 x 2.0
PN 315	DSE -30S	30	50.0	41.0	62.0	55.0	35.5	M42 x 2.0
	DSE -38S	38	60.0	50.0	72.0	63.0	41.0	M52 x 2.0

- Dimensions and Drawings are for reference only and are subject to change without prior notice.
- Unless otherwise specified, all dimensions are in millimeters.
- Sizes, pressure classes, and end connections not listed are available upon request.
- Length given approximate figure with tightened nut.

DSBT

Swivel Adjustable Branch Tee

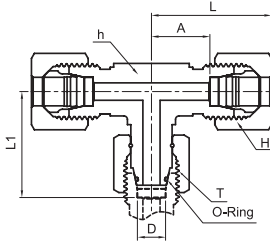
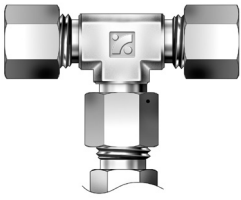

Series	Part No.	Tube O.D.	Dimension					
			H	h	L	L1	A	T
L Light PN 315	DSBT-06L	6	14.0	12.0	27.0	26.0	12.0	M12 x 1.5
	DSBT-08L	8	17.0	12.0	29.0	27.5	14.0	M14 x 1.5
	DSBT-10L	10	19.0	14.0	30.0	29.0	15.0	M16 x 1.5
	DSBT-12L	12	22.0	17.0	32.0	29.5	17.0	M18 x 1.5
	DSBT-15L	15	27.0	19.0	36.0	32.5	21.0	M22 x 1.5
	DSBT-18L	18	32.0	24.0	40.0	35.5	23.5	M26 x 1.5
PN 160	DSBT-22L	22	36.0	27.0	44.0	38.5	27.5	M30 x 2.0
	DSBT-28L	28	41.0	36.0	47.0	41.5	30.5	M36 x 2.0
	DSBT-35L	35	50.0	41.0	56.0	51.0	34.5	M45 x 2.0
	DSBT-42L	42	60.0	50.0	63.0	56.0	40.0	M52 x 2.0
S Heavy PN 630	DSBT-06S	6	17.0	12.0	31.0	27.0	16.0	M14 x 1.5
	DSBT-08S	8	19.0	14.0	32.0	27.5	17.0	M16 x 1.5
	DSBT-10S	10	22.0	17.0	34.0	30.0	17.5	M18 x 1.5
	DSBT-12S	12	24.0	17.0	38.0	31.0	21.5	M20 x 1.5
	DSBT-14S	14	27.0	19.0	40.0	35.0	22.0	M22 x 1.5
PN 400	DSBT-16S	16	30.0	24.0	43.0	36.5	24.5	M24 x 1.5
	DSBT-20S	20	36.0	27.0	48.0	44.5	26.5	M30 x 2.0
	DSBT-25S	25	46.0	36.0	54.0	50.0	30.0	M36 x 2.0
PN 315	DSBT-30S	30	50.0	41.0	62.0	55.0	35.5	M42 x 2.0
	DSBT-38S	38	60.0	50.0	72.0	63.0	41.0	M52 x 2.0

DSRT

Swivel Adjustable Run Tee

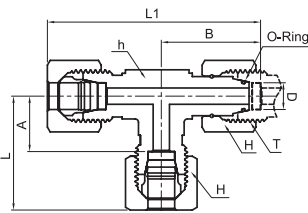
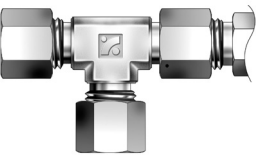

Series	Part No.	Tube O.D.	Dimension						
			H	h	L	L1	A	B	T
L Light PN 315	DSRT-06L	6	14.0	12.0	27.0	53.0	12.0	26.0	M12 x 1.5
	DSRT-08L	8	17.0	12.0	29.0	56.0	14.0	27.5	M14 x 1.5
	DSRT-10L	10	19.0	14.0	30.0	59.0	15.0	29.0	M16 x 1.5
	DSRT-12L	12	22.0	17.0	32.0	61.0	17.0	29.5	M18 x 1.5
	DSRT-15L	15	27.0	19.0	36.0	69.0	21.0	32.5	M22 x 1.5
	DSRT-18L	18	32.0	24.0	40.0	75.0	23.5	35.5	M26 x 1.5
PN 160	DSRT-22L	22	36.0	27.0	44.0	82.0	27.5	38.5	M30 x 2.0
	DSRT-28L	28	41.0	36.0	47.0	89.0	30.5	41.5	M36 x 2.0
	DSRT-35L	35	50.0	41.0	56.0	107.0	34.5	51.0	M45 x 2.0
	DSRT-42L	42	60.0	50.0	63.0	119.0	40.0	56.0	M52 x 2.0
S Heavy PN 630	DSRT-06S	6	17.0	12.0	31.0	58.0	16.0	27.0	M14 x 1.5
	DSRT-08S	8	19.0	14.0	32.0	59.0	17.0	27.5	M16 x 1.5
	DSRT-10S	10	22.0	17.0	34.0	64.0	17.5	30.0	M18 x 1.5
	DSRT-12S	12	24.0	17.0	38.0	69.0	21.5	31.0	M20 x 1.5
	DSRT-14S	14	27.0	19.0	40.0	75.0	22.0	35.0	M22 x 1.5
PN 400	DSRT-16S	16	30.0	24.0	43.0	79.0	24.5	36.5	M24 x 1.5
	DSRT-20S	20	36.0	27.0	48.0	93.0	26.5	44.5	M30 x 2.0
	DSRT-25S	25	46.0	36.0	54.0	104.0	30.0	50.0	M36 x 2.0
PN 315	DSRT-30S	30	50.0	41.0	62.0	117.0	35.5	55.0	M42 x 2.0
	DSRT-38S	38	60.0	50.0	72.0	135.0	41.0	63.0	M52 x 2.0

- Dimensions and Drawings are for reference only and are subject to change without prior notice.
- Unless otherwise specified, all dimensions are in millimeters.
- Sizes, pressure classes, and end connections not listed are available upon request.
- Length given approximate figure with tightened nut.

DRD
Reducer

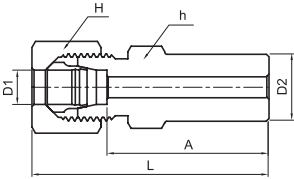
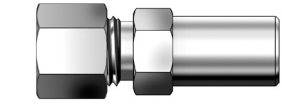

Series	Part No.	Tube OD		Dimension			
		D1	D2	H	h	L	A
L Light PN 315	DRD-06L-08L	6	8	14.0	12.0	40.0	25.5
	DRD-06L-10L	6	10	14.0	12.0	42.0	27.5
	DRD-08L-10L	8	10	17.0	14.0	43.0	27.5
	DRD-06L-12L	6	12	14.0	14.0	42.0	27.5
	DRD-08L-12L	8	12	17.0	14.0	43.0	27.5
	DRD-10L-12L	10	12	19.0	17.0	44.0	28.5
	DRD-06L-15L	6	15	14.0	19.0	44.0	29.0
	DRD-08L-15L	8	15	17.0	19.0	44.0	29.0
	DRD-10L-15L	10	15	19.0	19.0	45.0	30.0
	DRD-12L-15L	12	15	22.0	19.0	45.0	30.0
	DRD-06L-18L	6	18	14.0	19.0	46.0	31.0
	DRD-08L-18L	8	18	17.0	19.0	46.0	31.0
	DRD-10L-18L	10	18	19.0	19.0	47.0	32.0
	DRD-12L-18L	12	18	22.0	19.0	47.0	32.0
	DRD-15L-18L	15	18	27.0	22.0	49.0	33.0
PN 160	DRD-06L-22L	6	22	14.0	24.0	48.0	33.0
	DRD-08L-22L	8	22	17.0	24.0	48.0	33.0
	DRD-10L-22L	10	22	19.0	24.0	49.0	34.0
	DRD-12L-22L	12	22	22.0	24.0	49.0	34.0
	DRD-15L-22L	15	22	27.0	24.0	50.0	35.0
	DRD-18L-22L	18	22	32.0	27.0	51.0	34.5
	DRD-06L-28L	6	28	14.0	30.0	48.0	33.0
	DRD-08L-28L	8	28	17.0	30.0	48.0	33.0
	DRD-10L-28L	10	28	19.0	30.0	49.0	34.0
	DRD-12L-28L	12	28	22.0	30.0	49.0	34.0
	DRD-15L-28L	15	28	27.0	30.0	50.0	35.0
	DRD-18L-28L	18	28	32.0	30.0	51.0	36.0
	DRD-22L-28L	22	28	36.0	32.0	53.0	36.5
	DRD-06L-35L	6	35	14.0	36.0	53.0	38.5
	DRD-08L-35L	8	35	17.0	36.0	53.0	38.5
	DRD-10L-35L	10	35	19.0	36.0	55.0	39.5
	DRD-12L-35L	12	35	22.0	36.0	55.0	39.5
	DRD-15L-35L	15	35	27.0	36.0	56.0	40.5
	DRD-18L-35L	18	35	32.0	36.0	56.0	40.0
	DRD-22L-35L	22	35	36.0	36.0	58.0	42.0
	DRD-28L-35L	28	35	41.0	36.0	59.0	42.0
	DRD-06L-42L	6	42	14.0	46.0	56.0	41.0
	DRD-08L-42L	8	42	17.0	46.0	56.0	41.0
	DRD-10L-42L	10	42	19.0	46.0	58.0	42.0
	DRD-12L-42L	12	42	22.0	46.0	58.0	42.0
DRD-15L-42L	15	42	27.0	46.0	60.0	43.0	
DRD-18L-42L	18	42	32.0	46.0	60.0	42.5	
DRD-22L-42L	22	42	36.0	46.0	62.0	44.5	
DRD-28L-42L	28	42	41.0	46.0	64.0	44.5	
DRD-35L-42L	35	42	50.0	46.0	67.0	43.5	

- Dimensions and Drawings are for reference only and are subject to change without prior notice.
 - Unless otherwise specified, all dimensions are in millimeters.
 - Sizes, pressure classes, and end connections not listed are available upon request.
 - Length given approximate figure with tightened nut.

DRD

Reducer

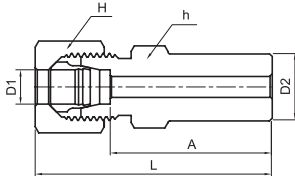
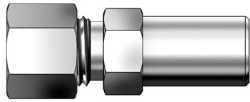

Series	Part No.	Tube OD		Dimension				
		D1	D2	H	h	L	A	
S Heavy PN 630	DRD-06S-08S	6	8	17.0	14.0	43.0	28.0	
	DRD-06S-10S	6	10	17.0	14.0	45.0	30.5	
	DRD-08S-10S	8	10	19.0	17.0	45.0	30.5	
	DRD-06S-12S	6	12	17.0	14.0	47.0	32.5	
	DRD-08S-12S	8	12	19.0	17.0	47.0	32.5	
	DRD-10S-12S	10	12	22.0	19.0	48.0	32.0	
	DRD-06S-14S	6	14	17.0	17.0	51.0	36.5	
	DRD-08S-14S	8	14	19.0	17.0	51.0	36.5	
	DRD-10S-14S	10	14	22.0	19.0	52.0	36.0	
	DRD-12S-14S	12	14	24.0	22.0	52.0	36.0	
	DRD-06S-16S	6	16	17.0	17.0	53.0	38.5	
	DRD-08S-16S	8	16	19.0	17.0	53.0	38.5	
	DRD-10S-16S	10	16	22.0	19.0	54.0	38.0	
	DRD-12S-16S	12	16	24.0	22.0	55.0	38.5	
	DRD-14S-16S	14	16	27.0	22.0	57.0	39.5	
	PN 400	DRD-06S-20S	6	20	17.0	22.0	58.0	43.0
		DRD-08S-20S	8	20	19.0	22.0	58.0	43.0
		DRD-10S-20S	10	20	22.0	22.0	59.0	42.5
		DRD-12S-20S	12	20	24.0	22.0	59.0	42.5
DRD-14S-20S		14	20	27.0	22.0	62.0	44.0	
DRD-16S-20S		16	20	30.0	24.0	62.0	43.5	
DRD-06S-25S		6	25	17.0	27.0	62.0	47.5	
DRD-08S-25S		8	25	19.0	27.0	62.0	47.5	
DRD-10S-25S		10	25	22.0	27.0	63.0	47.0	
DRD-12S-25S		12	25	24.0	27.0	63.0	47.0	
DRD-14S-25S		14	25	27.0	27.0	66.0	48.5	
DRD-16S-25S		16	25	30.0	27.0	66.0	48.0	
DRD-20S-25S		20	25	36.0	30.0	70.0	48.0	
DRD-06S-30S		6	30	17.0	32.0	67.0	52.0	
DRD-08S-30S		8	30	19.0	32.0	67.0	52.0	
DRD-10S-30S		10	30	22.0	32.0	68.0	51.5	
DRD-12S-30S		12	30	24.0	32.0	68.0	51.5	
DRD-14S-30S		14	30	27.0	32.0	71.0	53.0	
DRD-16S-30S		16	30	30.0	32.0	71.0	52.5	
DRD-20S-30S	20	30	36.0	32.0	74.0	52.5		
DRD-25S-30S	25	30	46.0	36.0	77.0	53.0		
PN 315	DRD-06S-38S	6	38	17.0	41.0	72.0	57.0	
	DRD-08S-38S	8	38	19.0	41.0	72.0	57.0	
	DRD-10S-38S	10	38	22.0	41.0	73.0	56.5	
	DRD-12S-38S	12	38	24.0	41.0	73.0	56.5	
	DRD-14S-38S	14	38	27.0	41.0	76.0	58.0	
	DRD-16S-38S	16	38	30.0	41.0	76.0	57.5	
	DRD-20S-38S	20	38	36.0	41.0	79.0	57.5	
	DRD-25S-38S	25	38	46.0	41.0	82.0	58.0	
DRD-30S-38S	30	38	50.0	46.0	89.0	58.5		

- Dimensions and Drawings are for reference only and are subject to change without prior notice.
 - Unless otherwise specified, all dimensions are in millimeters.
 - Sizes, pressure classes, and end connections not listed are available upon request.
 - Length given approximate figure with tightened nut.

DSRAP

Swivel Reducing Adaptor

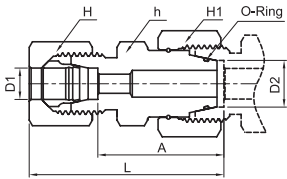
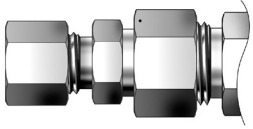

Series	Part No.	Tube OD		Dimension				
		D1	D2	H1	H	h	L	A
L Light PN 315	DSRAP-06L-08L	6	8	17.0	14.0	14.0	39.0	24.5
	DSRAP-06L-10L	6	10	19.0	14.0	17.0	39.5	24.5
	DSRAP-08L-10L	8	10	19.0	17.0	17.0	39.5	24.5
	DSRAP-06L-12L	6	12	22.0	14.0	17.0	40.0	25.0
	DSRAP-08L-12L	8	12	22.0	17.0	17.0	40.0	25.0
	DSRAP-10L-12L	10	12	22.0	19.0	17.0	41.0	26.0
	DSRAP-06L-15L	6	15	27.0	14.0	22.0	42.0	27.5
	DSRAP-08L-15L	8	15	27.0	17.0	22.0	42.0	27.5
	DSRAP-10L-15L	10	15	27.0	19.0	22.0	43.0	28.5
	DSRAP-12L-15L	12	15	27.0	22.0	22.0	43.0	28.5
	DSRAP-06L-18L	6	18	32.0	14.0	25.0	43.0	28.0
	DSRAP-08L-18L	8	18	32.0	17.0	25.0	43.0	28.0
	DSRAP-10L-18L	10	18	32.0	19.0	25.0	44.5	29.5
	DSRAP-12L-18L	12	18	32.0	22.0	25.0	44.5	29.5
	DSRAP-15L-18L	15	18	32.0	27.0	25.0	45.5	30.5
PN 160	DSRAP-06L-22L	6	22	36.0	14.0	28.5	47.0	32.0
	DSRAP-08L-22L	8	22	36.0	17.0	28.5	47.0	32.0
	DSRAP-10L-22L	10	22	36.0	19.0	28.5	48.0	33.0
	DSRAP-12L-22L	12	22	36.0	22.0	28.5	48.0	33.0
	DSRAP-15L-22L	15	22	36.0	27.0	28.5	49.0	34.0
	DSRAP-18L-22L	18	22	36.0	32.0	28.5	50.0	33.5
	DSRAP-06L-28L	6	28	41.0	14.0	36.0	49.0	34.0
	DSRAP-08L-28L	8	28	41.0	17.0	36.0	49.0	34.0
	DSRAP-10L-28L	10	28	41.0	19.0	36.0	50.0	35.0
	DSRAP-12L-28L	12	28	41.0	22.0	36.0	50.0	35.0
	DSRAP-15L-28L	15	28	41.0	27.0	36.0	51.0	36.0
	DSRAP-18L-28L	18	28	41.0	32.0	36.0	52.0	35.5
	DSRAP-22L-28L	22	28	41.0	36.0	36.0	54.0	37.5
	DSRAP-06L-35L	6	35	50.0	14.0	46.0	55.0	40.0
	DSRAP-08L-35L	8	35	50.0	17.0	46.0	55.0	40.0
	DSRAP-10L-35L	10	35	50.0	19.0	46.0	56.0	41.0
	DSRAP-12L-35L	12	35	50.0	22.0	46.0	56.0	41.0
	DSRAP-15L-35L	15	35	50.0	27.0	46.0	57.0	42.0
	DSRAP-18L-35L	18	35	50.0	32.0	46.0	58.0	41.5
	DSRAP-22L-35L	22	35	50.0	36.0	46.0	60.0	43.5
	DSRAP-28L-35L	28	35	50.0	41.0	46.0	60.0	43.5
DSRAP-06L-42L	6	42	60.0	14.0	50.0	55.0	40.5	
DSRAP-08L-42L	8	42	60.0	17.0	50.0	55.0	40.5	
DSRAP-10L-42L	10	42	60.0	19.0	50.0	56.0	41.5	
DSRAP-12L-42L	12	42	60.0	22.0	50.0	56.0	41.5	
DSRAP-15L-42L	15	42	60.0	27.0	50.0	58.0	42.5	
DSRAP-18L-42L	18	42	60.0	32.0	50.0	58.0	42.0	
DSRAP-22L-42L	22	42	60.0	36.0	50.0	60.0	44.0	
DSRAP-28L-42L	28	42	60.0	41.0	50.0	61.0	44.0	
DSRAP-35L-42L	35	42	60.0	50.0	50.0	65.0	43.0	

- Dimensions and Drawings are for reference only and are subject to change without prior notice.
 - Unless otherwise specified, all dimensions are in millimeters.
 - Sizes, pressure classes, and end connections not listed are available upon request.
 - Length given approximate figure with tightened nut.

DSRAP

Swivel Reducing Adaptor

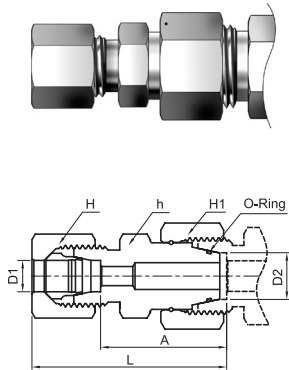

Series	Part No.	Tube OD		Dimension				
		D1	D2	H1	H	h	L	A
S Heavy PN 630	DSRAP-06S-08S	6	8	19.0	17.0	17.0	44.0	28.0
	DSRAP-06S-10S	6	10	22.0	17.0	17.0	44.0	29.5
	DSRAP-08S-10S	8	10	22.0	19.0	17.0	44.0	29.5
	DSRAP-06S-12S	6	12	24.0	17.0	19.0	45.0	30.0
	DSRAP-08S-12S	8	12	24.0	19.0	19.0	45.0	30.0
	DSRAP-10S-12S	10	12	24.0	22.0	19.0	46.0	29.5
	DSRAP-06S-14S	6	14	27.0	17.0	22.0	47.5	33.0
	DSRAP-08S-14S	8	14	27.0	19.0	22.0	47.5	33.0
	DSRAP-10S-14S	10	14	27.0	22.0	22.0	48.5	32.5
	DSRAP-12S-14S	12	14	27.0	24.0	22.0	48.5	32.5
	DSRAP-06S-16S	6	16	30.0	17.0	24.0	50.0	35.0
	DSRAP-08S-16S	8	16	30.0	19.0	24.0	50.0	35.0
	DSRAP-10S-16S	10	16	30.0	22.0	24.0	51.0	34.5
	DSRAP-12S-16S	12	16	30.0	24.0	24.0	51.0	34.5
	DSRAP-14S-16S	14	16	30.0	27.0	24.0	54.0	36.0
PN 400	DSRAP-06S-20S	6	20	36.0	17.0	28.5	54.0	39.0
	DSRAP-08S-20S	8	20	36.0	19.0	28.5	54.0	39.0
	DSRAP-10S-20S	10	20	36.0	22.0	28.5	55.0	38.5
	DSRAP-12S-20S	12	20	36.0	24.0	28.5	55.0	38.5
	DSRAP-14S-20S	14	20	36.0	27.0	28.5	58.0	40.0
	DSRAP-16S-20S	16	20	36.0	30.0	28.5	58.0	39.5
	DSRAP-06S-25S	6	25	46.0	17.0	36.0	58.0	43.5
	DSRAP-08S-25S	8	25	46.0	19.0	36.0	58.0	43.5
	DSRAP-10S-25S	10	25	46.0	22.0	36.0	59.0	43.0
	DSRAP-12S-25S	12	25	46.0	24.0	36.0	59.0	43.0
	DSRAP-14S-25S	14	25	46.0	27.0	36.0	62.0	44.5
	DSRAP-16S-25S	16	25	46.0	30.0	36.0	62.0	44.0
	DSRAP-20S-25S	20	25	46.0	36.0	36.0	66.0	44.0
	DSRAP-06S-30S	6	30	50.0	17.0	41.0	66.0	51.0
	DSRAP-08S-30S	8	30	50.0	19.0	41.0	66.0	51.0
DSRAP-10S-30S	10	30	50.0	22.0	41.0	67.0	50.5	
DSRAP-12S-30S	12	30	50.0	24.0	41.0	67.0	50.5	
DSRAP-14S-30S	14	30	50.0	27.0	41.0	70.0	52.0	
DSRAP-16S-30S	16	30	50.0	30.0	41.0	70.0	51.5	
DSRAP-20S-30S	20	30	50.0	36.0	41.0	73.0	51.5	
DSRAP-25S-30S	25	30	50.0	46.0	41.0	76.0	52.0	
PN 315	DSRAP-06S-38S	6	38	60.0	17.0	50.0	70.5	56.0
	DSRAP-08S-38S	8	38	60.0	19.0	50.0	70.5	56.0
	DSRAP-10S-38S	10	38	60.0	22.0	50.0	71.5	55.5
	DSRAP-12S-38S	12	38	60.0	24.0	50.0	71.5	55.5
	DSRAP-14S-38S	14	38	60.0	27.0	50.0	74.5	57.0
	DSRAP-16S-38S	16	38	60.0	30.0	50.0	74.5	56.5
	DSRAP-20S-38S	20	38	60.0	36.0	50.0	78.5	56.5
DSRAP-25S-38S	25	38	60.0	46.0	50.0	81.5	57.0	
DSRAP-30S-38S	30	38	60.0	50.0	50.0	85.5	58.5	

- Dimensions and Drawings are for reference only and are subject to change without prior notice.
- Unless otherwise specified, all dimensions are in millimeters.
- Sizes, pressure classes, and end connections not listed are available upon request.
- Length given approximate figure with tightened nut.

DAP-GED/MED (BSP Parallel/Metric Parallel with ED-Ring)

Adaptor

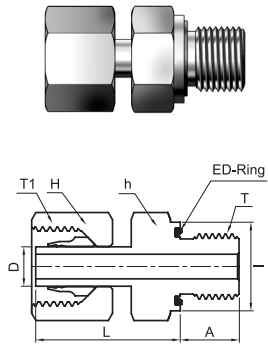

BSP Parallel Thread Type

Series	Part No.	Tube O.D.	Dimension						
			H	h	l	L	A	T	T1
L Light PN315	DAP-06L-01GED	6	14.0	14.0	14.0	24.5	8.0	PF 1/8	M12 x 1.5
	DAP-08L-02GED	8	17.0	19.0	19.0	29.5	12.0	PF 1/4	M14 x 1.5
	DAP-10L-02GED	10	19.0	19.0	19.0	27.5	12.0	PF 1/4	M16 x 1.5
	DAP-12L-03GED	12	22.0	22.0	22.0	34.0	12.0	PF 3/8	M18 x 1.5
	DAP-15L-04GED	15	27.0	27.0	27.0	32.0	14.0	PF 1/2	M22 x 1.5
	DAP-18L-04GED	18	32.0	27.0	27.0	31.5	14.0	PF 1/2	M26 x 1.5
PN 160	DAP-22L-06GED	22	36.0	32.0	32.0	32.5	16.0	PF 3/4	M30 x 2.0
	DAP-28L-08GED	28	41.0	41.0	40.0	35.0	18.0	PF 1	M36 x 2.0
	DAP-35L-10GED	35	50.0	50.0	50.0	42.5	20.0	PF 1-1/4	M45 x 2.0
	DAP-42L-12GED	42	60.0	55.0	55.0	46.5	22.0	PF 1-1/2	M52 x 2.0
S Heavy PB 630	DAP-06S-02GED	6	17.0	19.0	19.0	27.0	12.0	PF 1/4	M14 x 1.5
	DAP-08S-02GED	8	19.0	19.0	19.0	29.5	12.0	PF 1/4	M16 x 1.5
	DAP-10S-03GED	10	22.0	22.0	22.0	32.0	12.0	PF 3/8	M18 x 1.5
	DAP-12S-03GED	12	24.0	22.0	22.0	34.0	12.0	PF 3/8	M20 x 1.5
	DAP-12S-04GED	12	24.0	27.0	27.0	34.5	14.0	PF 1/2	M20 x 1.5
	DAP-14S-04GED	14	27.0	27.0	27.0	36.5	14.0	PF 1/2	M22 x 1.5
PN 400	DAP-16S-04GED	16	30.0	27.0	27.0	37.0	14.0	PF 1/2	M24 x 1.5
	DAP-16S-06GED	16	30.0	32.0	32.0	39.0	16.0	PF 3/4	M24 x 1.5
	DAP-20S-06GED	20	36.0	32.0	32.0	43.0	16.0	PF 3/4	M30 x 2.0
	DAP-25S-08GED	25	46.0	41.0	40.0	48.0	18.0	PF 1	M36 x 2.0
	DAP-30S-10GED	30	50.0	50.0	50.0	51.0	20.0	PF 1-1/4	M42 x 2.0
PN 315	DAP-38S-12GED	38	60.0	55.0	55.0	60.0	22.0	PF 1-1/2	M52 x 2.0

Metric Parallel Thread Type

Series	Part No.	Tube O.D.	Dimension (mm)						
			H	h	l	L	A	T	T1
L Light PN315	DAP-06L-M10ED	6	14.0	14.0	14.0	24.5	8.0	M10 x 1.0	M12 x 1.5
	DAP-08L-M12ED	8	17.0	17.0	17.0	26.5	12.0	M12 x 1.5	M14 x 1.5
	DAP-10L-M14ED	10	19.0	19.0	19.0	27.5	12.0	M14 x 1.5	M16 x 1.5
	DAP-12L-M16ED	12	22.0	22.0	22.0	30.5	12.0	M16 x 1.5	M18 x 1.5
	DAP-15L-M18ED	15	27.0	24.0	24.0	31.5	14.0	M18 x 1.5	M22 x 1.5
	DAP-18L-M22ED	18	32.0	27.0	27.0	31.5	14.0	M22 x 1.5	M26 x 1.5
PN 160	DAP-22L-M26ED	22	36.0	32.0	32.0	32.5	16.0	M26 x 1.5	M30 x 2.0
	DAP-28L-M33ED	28	41.0	41.0	40.0	35.0	18.0	M33 x 2.0	M36 x 2.0
	DAP-35L-M42ED	35	50.0	50.0	50.0	42.5	20.0	M42 x 2.0	M45 x 2.0
	DAP-42L-M48ED	42	60.0	55.0	55.0	46.5	22.0	M48 x 2.0	M52 x 2.0
S Heavy PB 630	DAP-06S-M12ED	6	17.0	17.0	17.0	27.0	12.0	M12 x 1.5	M14 x 1.5
	DAP-08S-M14ED	8	19.0	19.0	19.0	29.5	12.0	M14 x 1.5	M16 x 1.5
	DAP-10S-M16ED	10	22.0	22.0	22.0	32.0	12.0	M16 x 1.5	M18 x 1.5
	DAP-12S-M18ED	12	24.0	24.0	24.0	34.0	12.0	M18 x 1.5	M20 x 1.5
	DAP-14S-M20ED	14	27.0	27.0	27.0	36.5	14.0	M20 x 1.5	M22 x 1.5
	DAP-16S-M22ED	16	30.0	27.0	27.0	37.0	14.0	M22 x 1.5	M24 x 1.5
PN 400	DAP-20S-M27ED	20	36.0	32.0	32.0	43.0	16.0	M27 x 2.0	M30 x 2.0
	DAP-25S-M33ED	25	46.0	41.0	40.0	48.0	18.0	M33 x 2.0	M36 x 2.0
	DAP-30S-M42ED	30	50.0	50.0	50.0	51.0	20.0	M42 x 2.0	M42 x 2.0
	DAP-38S-M48ED	38	60.0	55.0	55.0	60.0	22.0	M48 x 2.0	M52 x 2.0

- Dimensions and Drawings are for reference only and are subject to change without prior notice.
- Unless otherwise specified, all dimensions are in millimeters.
- Sizes, pressure classes, and end connections not listed are available upon request.
- Length given approximate figure with tightened nut.

DSAP-GED/MED (BSP Parallel/Metric Parallel with ED-Ring)

Swivel Adaptor

BSP Parallel Thread Type

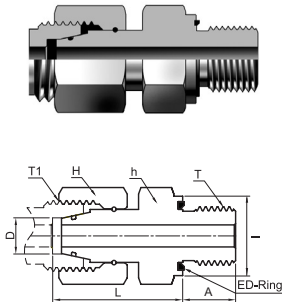

Series	Part No.	Tube O.D.	Dimension						
			H	h	I	L	A	T	T1
L Light PN315	DSAP-06L-01GED	6	14.0	14.0	14.0	24.5	8.0	PF 1/8	M12 x 1.5
	DSAP-08L-02GED	8	17.0	19.0	19.0	29.5	12.0	PF 1/4	M14 x 1.5
	DSAP-10L-02GED	10	19.0	19.0	19.0	27.5	12.0	PF 1/4	M16 x 1.5
	DSAP-12L-03GED	12	22.0	22.0	22.0	34.0	12.0	PF 3/8	M18 x 1.5
	DSAP-15L-04GED	15	27.0	27.0	27.0	32.0	14.0	PF 1/2	M22 x 1.5
	DSAP-18L-04GED	18	32.0	27.0	27.0	31.5	14.0	PF 1/2	M26 x 1.5
PN 160	DSAP-22L-06GED	22	36.0	32.0	32.0	32.5	16.0	PF 3/4	M30 x 2.0
	DSAP-28L-08GED	28	41.0	41.0	40.0	35.0	18.0	PF 1	M36 x 2.0
	DSAP-35L-10GED	35	50.0	50.0	50.0	42.5	20.0	PF 1-1/4	M45 x 2.0
	DSAP-42L-12GED	42	60.0	55.0	55.0	46.5	22.0	PF 1-1/2	M52 x 2.0
S Heavy PB 630	DSAP-06S-02GED	6	17.0	19.0	19.0	27.0	12.0	PF 1/4	M14 x 1.5
	DSAP-08S-02GED	8	19.0	19.0	19.0	29.5	12.0	PF 1/4	M16 x 1.5
	DSAP-10S-03GED	10	22.0	22.0	22.0	32.0	12.0	PF 3/8	M18 x 1.5
	DSAP-12S-03GED	12	24.0	22.0	22.0	34.0	12.0	PF 3/8	M20 x 1.5
	DSAP-14S-04GED	14	27.0	27.0	27.0	36.5	14.0	PF 1/2	M22 x 1.5
PN 400	DSAP-16S-04GED	16	30.0	27.0	27.0	37.0	14.0	PF 1/2	M24 x 1.5
	DSAP-20S-06GED	20	36.0	32.0	32.0	43.0	16.0	PF 3/4	M30 x 2.0
	DSAP-25S-08GED	25	46.0	41.0	40.0	48.0	18.0	PF 1	M36 x 2.0
	DSAP-30S-10GED	30	50.0	50.0	50.0	51.0	20.0	PF 1-1/4	M42 x 2.0
PN 315	DSAP-38S-12GED	38	60.0	55.0	55.0	60.0	22.0	PF 1-1/2	M52 x 2.0

Metric Parallel Thread Type

Series	Part No.	Tube O.D.	Dimension						
			H	h	I	L	A	T	T1
L Light PN315	DSAP-06L-M10ED	6	14.0	14.0	14.0	24.5	8.0	M10 x 1.0	M12 x 1.5
	DSAP-08L-M12ED	8	17.0	19.0	17.0	26.5	12.0	M12 x 1.5	M14 x 1.5
	DSAP-10L-M14ED	10	19.0	19.0	19.0	27.5	12.0	M14 x 1.5	M16 x 1.5
	DSAP-12L-M16ED	12	22.0	22.0	22.0	30.5	12.0	M16 x 1.5	M18 x 1.5
	DSAP-15L-M18ED	15	27.0	24.0	24.0	31.5	12.0	M18 x 1.5	M22 x 1.5
	DSAP-18L-M22ED	18	32.0	27.0	27.0	31.5	14.0	M22 x 1.5	M26 x 1.5
PN 160	DSAP-22L-M26ED	22	36.0	32.0	32.0	32.5	16.0	M26 x 1.5	M30 x 2.0
	DSAP-28L-M33ED	28	41.0	41.0	40.0	35.0	18.0	M33 x 2.0	M36 x 2.0
	DSAP-35L-M42ED	35	50.0	50.0	50.0	42.5	20.0	M42 x 2.0	M45 x 2.0
	DSAP-42L-M48ED	42	60.0	55.0	55.0	46.5	22.0	M48 x 2.0	M52 x 2.0
S Heavy PB 630	DSAP-06S-M12ED	6	17.0	17.0	17.0	27.0	12.0	M12 x 1.5	M14 x 1.5
	DSAP-08S-M14ED	8	19.0	19.0	19.0	29.5	12.0	M14 x 1.5	M16 x 1.5
	DSAP-10S-M16ED	10	22.0	22.0	22.0	32.0	12.0	M16 x 1.5	M18 x 1.5
	DSAP-12S-M18ED	12	24.0	24.0	24.0	34.0	12.0	M18 x 1.5	M20 x 1.5
	DSAP-14S-M20ED	14	27.0	27.0	26.0	36.5	14.0	M20 x 1.5	M22 x 1.5
PN 400	DSAP-16S-M22ED	16	30.0	27.0	27.0	37.0	14.0	M22 x 1.5	M24 x 1.5
	DSAP-20S-M27ED	20	36.0	32.0	32.0	43.0	16.0	M27 x 2.0	M30 x 2.0
	DSAP-25S-M33ED	25	46.0	41.0	40.0	48.0	18.0	M33 x 2.0	M36 x 2.0
	DSAP-30S-M42ED	30	50.0	50.0	50.0	51.0	20.0	M42 x 2.0	M45 x 2.0
PN 315	DSAP-38S-M48ED	38	60.0	55.0	55.0	60.0	22.0	M48 x 2.0	M52 x 2.0

- Dimensions and Drawings are for reference only and are subject to change without prior notice.
- Unless otherwise specified, all dimensions are in millimeters.
- Sizes, pressure classes, and end connections not listed are available upon request.
- Length given approximate figure with tightened nut.

DSLU

Swivel Union

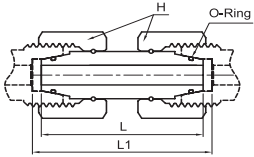

Series	Part No.	Tube O.D.	Dimension		
			H	L	L1
L Light PN500	DSLU-06L	6	17.0	34.0	36.0
	DSLU-08L	8	17.0	34.0	36.0
	DSLU-10L	10	19.0	36.0	37.0
PB 400	DSLU-12L	12	22.0	36.0	37.0
	DSLU-15L	15	27.0	39.0	40.0
	DSLU-18L	18	32.0	40.5	42.5
PB 250	DSLU-22L	22	36.0	45.0	47.0
	DSLU-28L	28	46.0	47.0	49.0
	DSLU-35L	35	50.0	53.0	58.0
	DSLU-42L	42	60.0	53.0	59.0
S Heavy PB 800	DSLU-06S	6	17.0	37.0	39.0
	DSLU-08S	8	19.0	37.0	39.0
	DSLU-10S	10	22.0	41.0	43.0
PN 630	DSLU-12S	12	24.0	43.0	44.0
	DSLU-14S	14	27.0	45.0	48.0
	DSLU-16S	16	30.0	46.0	50.0
PN 400	DSLU-20S	20	36.0	55.0	60.0
	DSLU-25S	25	46.0	58.0	66.0
	DSLU-30S	30	50.0	62.0	73.0
	DSLU-38S	38	60.0	67.0	83.0

- Dimensions and Drawings are for reference only and are subject to change without prior notice.
- Unless otherwise specified, all dimensions are in millimeters.
- Sizes, pressure classes, and end connections not listed are available upon request.
- Length given approximate figure with tightened nut.

DBE-G/M (BSP Parallel/Metric Parallel)

Banjo Elbow

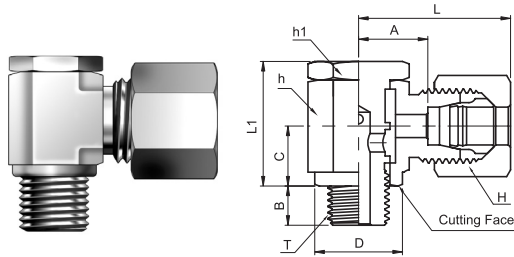

For Tube OD up to 15mm

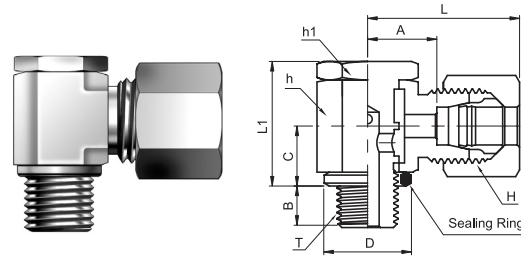

For Tube OD 16mm and larger

BSP Parallel Thread Type

Series	Part No.	Tube O.D.	Dimension									
			D	H	h	h1	L	L1	A	B	C	T
L Light PB 250	DBE-06L-01G	6	14.0	14.0	14.0	14.0	25.0	21.0	10.5	6.0	10.0	PF 1/8
	DBE-08L-02G	8	18.0	17.0	19.0	19.0	28.0	27.0	13.0	9.0	13.0	PF 1/4
	DBE-10L-02G	10	18.0	19.0	19.0	19.0	29.0	27.0	14.0	9.0	13.0	PF 1/4
	DBE-12L-03G	12	22.0	22.0	22.0	22.0	30.0	32.0	15.5	9.0	15.0	PF 3/8
	DBE-15L-04G	15	26.0	27.0	27.0	27.0	34.0	37.5	19.0	11.0	18.0	PF 1/2
PB 160	DBE-18L-04G	18	26.0	32.0	30.0	27.0	37.0	44.0	20.5	11.0	21.5	PF 1/2
	DBE-22L-06G	22	32.0	36.0	36.0	32.0	42.0	49.0	25.5	13.0	24.0	PF 3/4
S Heavy PB 250	DBE-06S-02G	6	18.0	17.0	19.0	19.0	30.0	27.0	15.0	9.0	13.0	PF 1/4
	DBE-08S-02G	8	18.0	19.0	19.0	19.0	30.0	27.0	15.0	9.0	13.0	PF 1/4
	DBE-10S-03G	10	22.0	22.0	22.0	22.0	32.0	32.0	16.0	9.0	15.0	PF 3/8
	DBE-12S-03G	12	22.0	24.0	24.0	24.0	33.0	37.0	17.0	9.0	18.0	PF 3/8
	DBE-14S-04G	14	26.0	27.0	27.0	27.0	38.0	37.0	20.0	11.0	18.0	PF 1/2
PB 160	DBE-16S-04G	16	26.0	30.0	30.0	27.0	40.0	44.0	21.5	11.0	21.5	PF 1/2
	DBE-20S-06G	20	32.0	36.0	36.0	32.0	46.0	49.0	24.5	13.0	24.0	PF 3/4

* ISO/BSP parallel gaskets are available. See page 13.

Metric Parallel Thread Type

Series	Part No.	Tube O.D.	Dimension									
			D	H	h	h1	L	L1	A	B	C	T
L Light PB 250	DBE-06L-M10	6	14.0	14.0	14.0	14.0	25.0	21.5	10.5	6.0	10.0	M10 x 1.0
	DBE-08L-M12	8	17.0	17.0	17.0	17.0	27.0	25.0	12.0	9.0	12.0	M12 x 1.5
	DBE-10L-M14	10	19.0	19.0	19.0	19.0	29.0	27.0	14.0	9.0	13.0	M14 x 1.5
	DBE-12L-M16	12	21.0	22.0	22.0	22.0	30.0	32.0	15.5	9.0	15.0	M16 x 1.5
	DBE-15L-M18	15	23.0	27.0	24.0	24.0	33.0	37.5	17.5	9.0	18.0	M18 x 1.5
PB 160	DBE-18L-M22	18	27.0	32.0	30.0	27.0	37.0	44.0	20.5	11.0	21.5	M22 x 1.5
	DBE-22L-M26	22	31.0	36.0	36.0	32.0	42.0	49.0	25.5	13.0	24.0	M26 x 1.5
S Heavy PB 250	DBE-06S-M12	6	17.0	17.0	17.0	17.0	29.0	25.0	14.0	9.0	12.0	M12 x 1.5
	DBE-08S-M14	8	19.0	19.0	19.0	19.0	30.0	27.0	15.0	9.0	13.0	M14 x 1.5
	DBE-10S-M16	10	21.0	22.0	22.0	22.0	32.0	32.0	16.0	9.0	15.0	M16 x 1.5
	DBE-12S-M18	12	23.0	24.0	24.0	24.0	33.0	37.0	17.0	9.0	18.0	M18 x 1.5
	DBE-14S-M20	14	25.0	27.0	27.0	27.0	38.0	37.0	20.0	11.0	18.0	M20 x 1.5
PB 160	DBE-16S-M22	16	27.0	30.0	30.0	27.0	40.0	44.0	21.5	11.0	21.5	M22 x 1.5
	DBE-20S-M27	20	32.0	36.0	36.0	32.0	46.0	49.0	24.5	13.0	24.0	M27 x 2.0

- Dimensions and Drawings are for reference only and are subject to change without prior notice.
- Unless otherwise specified, all dimensions are in millimeters.
- Sizes, pressure classes, and end connections not listed are available upon request.
- Length given approximate figure with tightened nut.

DHBE-G/M (BSP Parallel/Metric Parallel)

High Pressure Banjo Elbow

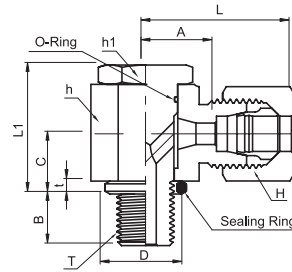
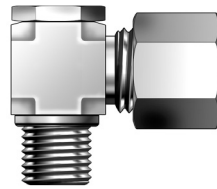

BSP Parallel Thread Type

Series	Part No.	Tube O.D.	Dimension										
			D	H	h	h1	L	L1	A	B	C	t	T
L Light PB 315	DHBE-06L-01G	6	14.0	14.0	17.0	17.0	27.0	24.0	12.0	8.0	10.5	2.5	PF 1/8
	DHBE-08L-02G	8	18.0	17.0	22.0	19.0	29.0	30.0	14.5	12.0	14.0	3.0	PF 1/4
	DHBE-10L-02G	10	18.0	19.0	22.0	19.0	30.0	30.0	15.5	12.0	14.0	3.0	PF 1/4
	DHBE-12L-03G	12	22.0	22.0	27.0	24.0	33.0	36.0	18.0	12.0	16.5	3.0	PF 3/8
	DHBE-15L-04G	15	26.0	27.0	32.0	30.0	37.0	45.0	21.5	14.0	21.5	4.5	PF 1/2
PB 160	DHBE-18L-04G	18	26.0	32.0	32.0	30.0	37.0	45.0	21.0	14.0	21.5	4.5	PF 1/2
	DHBE-22L-06G	22	32.0	36.0	41.0	36.0	44.0	53.0	27.5	16.0	24.0	3.5	PF 3/4
	DHBE-28L-08G	28	39.0	41.0	50.0	46.0	49.0	66.0	32.0	18.0	30.5	3.5	PF 1
	DHBE-35L-10G	35	49.0	50.0	60.0	55.0	58.0	76.0	36.0	20.0	35.5	3.5	PF 1-1/4
S Heavy PB 400	DHBE-42L-12G	42	55.0	60.0	70.0	60.0	63.0	87.0	40.5	22.0	40.5	3.5	PF 1-1/2
	DHBE-06S-02G	6	18.0	17.0	22.0	19.0	31.0	30.0	16.5	12.0	14.0	3.0	PF 1/4
	DHBE-08S-02G	8	18.0	19.0	22.0	19.0	31.0	30.0	16.5	12.0	14.0	3.0	PF 1/4
	DHBE-10S-03G	10	22.0	22.0	27.0	24.0	35.0	36.0	18.5	12.0	16.5	3.0	PF 3/8
	DHBE-12S-03G	12	22.0	24.0	27.0	24.0	35.0	36.0	18.5	12.0	16.5	3.0	PF 3/8
	DHBE-16S-04G	16	26.0	30.0	32.0	30.0	40.0	45.0	22.0	14.0	21.5	4.5	PF 1/2
PB 250	DHBE-20S-06G	20	32.0	36.0	41.0	36.0	48.0	53.0	26.5	16.0	24.0	3.5	PF 3/4
	DHBE-25S-08G	25	39.0	46.0	50.0	46.0	56.0	66.0	31.5	18.0	30.5	3.5	PF 1
	DHBE-30S-10G	30	49.0	50.0	60.0	55.0	64.0	76.0	37.0	20.0	34.5	3.5	PF 1-1/4
	DHBE-38S-12G	38	55.0	60.0	70.0	60.0	72.0	87.0	41.5	22.0	40.5	3.5	PF 1-1/2

Metric Parallel Thread Type

Series	Part No.	Tube O.D.	Dimension										
			D	H	h	h1	L	L1	A	B	C	t	T
L Light PB 315	DHBE-06L-M10	6	14.0	14.0	17.0	17.0	27.0	24.0	12.0	8.0	10.5	2.5	M10 x 1.0
	DHBE-08L-M12	8	17.0	17.0	22.0	19.0	29.0	30.0	14.5	12.0	14.0	3.0	M12 x 1.5
	DHBE-10L-M14	10	19.0	19.0	22.0	19.0	30.0	30.0	15.5	12.0	14.0	3.0	M14 x 1.5
	DHBE-12L-M16	12	21.0	22.0	27.0	24.0	33.0	36.0	18.0	12.0	16.5	3.0	M16 x 1.5
	DHBE-15L-M18	15	23.0	27.0	30.0	27.0	36.0	39.5	20.5	12.0	18.5	3.0	M18 x 1.5
	DHBE-18L-M22	18	27.0	32.0	32.0	30.0	37.0	45.0	21.0	14.0	21.5	4.5	M22 x 1.5
PB 160	DHBE-22L-M26	22	31.0	36.0	41.0	36.0	44.0	53.0	27.5	16.0	24.0	3.5	M26 x 1.5
	DHBE-28L-M33	28	39.0	41.0	50.0	46.0	49.0	66.0	32.0	18.0	30.5	3.5	M33 x 2.0
	DHBE-35L-M42	35	49.0	50.0	60.0	55.0	58.0	76.0	36.0	20.0	35.5	3.5	M42 x 2.0
	DHBE-42L-M48	42	55.0	60.0	70.0	60.0	63.0	87.0	40.5	22.0	40.5	3.5	M48 x 2.0
S Heavy PB 400	DHBE-06S-M12	6	17.0	17.0	22.0	19.0	31.0	30.0	16.5	12.0	14.0	3.0	M12 x 1.5
	DHBE-08S-M14	8	19.0	19.0	22.0	19.0	31.0	30.0	16.5	12.0	14.0	3.0	M14 x 1.5
	DHBE-10S-M16	10	21.0	22.0	27.0	24.0	35.0	36.0	18.5	12.0	16.5	3.0	M16 x 1.5
	DHBE-12S-M18	12	23.0	24.0	30.0	27.0	36.0	39.5	20.0	12.0	18.5	3.0	M18 x 1.5
	DHBE-16S-M22	16	27.0	30.0	32.0	30.0	40.0	45.0	22.0	14.0	21.5	4.5	M22 x 1.5
	DHBE-20S-M27	20	32.0	36.0	41.0	36.0	48.0	53.0	26.5	16.0	24.0	3.5	M27 x 2.0
PB 160	DHBE-25S-M33	25	39.0	46.0	50.0	46.0	56.0	66.0	31.5	18.0	30.5	3.5	M33 x 2.0
	DHBE-30S-M42	30	49.0	50.0	60.0	55.0	64.0	76.0	37.0	20.0	35.5	3.5	M42 x 2.0
	DHBE-38S-M48	38	55.0	60.0	70.0	60.0	72.0	87.0	41.5	22.0	40.5	3.5	M48 x 2.0

- Dimensions and Drawings are for reference only and are subject to change without prior notice.
- Unless otherwise specified, all dimensions are in millimeters.
- Sizes, pressure classes, and end connections not listed are available upon request.
- Length given approximate figure with tightened nut.

DHBT-G/M (BSP Parallel/Metric Parallel)

High Pressure Banjo Tee

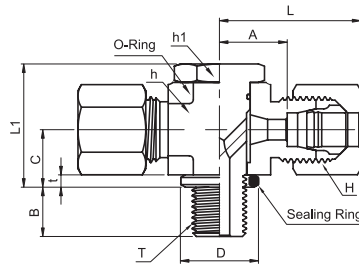
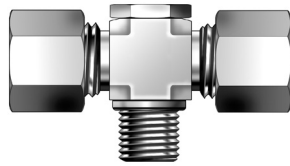

BSP Parallel Thread Type

Series	Part No.	Tube O.D.	Dimension										
			D	H	h	h1	L	L1	A	B	C	t	T
L Light PB 315	DHBT-06L-01G	6	14.0	14.0	17.0	17.0	27.0	24.0	12.0	8.0	10.5	2.5	PF 1/8
	DHBT-08L-02G	8	18.0	17.0	22.0	19.0	29.0	30.0	14.5	12.0	14.0	3.0	PF 1/4
	DHBT-10L-02G	10	18.0	19.0	22.0	19.0	30.0	30.0	15.5	12.0	14.0	3.0	PF 1/4
	DHBT-12L-03G	12	22.0	22.0	27.0	24.0	33.0	36.0	18.0	12.0	16.5	3.0	PF 3/8
	DHBT-15L-04G	15	26.0	27.0	32.0	30.0	37.0	45.0	21.5	14.0	21.5	4.5	PF 1/2
	DHBT-18L-04G	18	26.0	32.0	32.0	30.0	37.0	45.0	21.0	14.0	21.5	4.5	PF 1/2
PB 160	DHBT-22L-06G	22	32.0	36.0	41.0	36.0	44.0	53.0	27.5	16.0	24.0	3.5	PF 3/4
	DHBT-28L-08G	28	39.0	41.0	50.0	46.0	49.0	66.0	32.0	18.0	30.5	3.5	PF 1
	DHBT-35L-10G	35	49.0	50.0	60.0	55.0	58.0	76.0	36.0	20.0	35.5	3.5	PF 1-1/4
	DHBT-42L-12G	42	55.0	60.0	70.0	60.0	63.0	87.0	40.5	22.0	40.5	3.5	PF 1-1/2
S Heavy PB 400	DHBT-06S-02G	6	18.0	17.0	22.0	19.0	31.0	30.0	16.5	12.0	14.0	3.0	PF 1/4
	DHBT-08S-02G	8	18.0	19.0	22.0	19.0	31.0	30.0	16.5	12.0	14.0	3.0	PF 1/4
	DHBT-10S-03G	10	22.0	22.0	27.0	24.0	35.0	36.0	18.5	12.0	16.5	3.0	PF 3/8
	DHBT-12S-03G	12	22.0	24.0	27.0	24.0	35.0	36.0	18.5	12.0	16.5	3.0	PF 3/8
	DHBT-16S-04G	16	26.0	30.0	32.0	30.0	40.0	45.0	22.0	14.0	21.5	4.5	PF 1/2
	DHBT-20S-06G	20	32.0	36.0	41.0	36.0	48.0	53.0	26.5	16.0	24.0	3.5	PF 3/4
PB 250	DHBT-25S-08G	25	39.0	46.0	50.0	46.0	56.0	66.0	31.5	18.0	30.5	3.5	PF 1
	DHBT-30S-10G	30	49.0	50.0	60.0	55.0	64.0	76.0	37.0	20.0	35.5	3.5	PF 1-1/4
	DHBT-38S-12G	38	55.0	60.0	70.0	60.0	72.0	87.0	41.5	22.0	40.5	3.5	PF 1-1/2

Metric Parallel Thread Type

Series	Part No.	Tube O.D.	Dimension										
			D	H	h	h1	L	L1	A	B	C	t	T
L Light PB 315	DHBT-06L-M10	6	14.0	14.0	17.0	17.0	27.0	24.0	12.0	8.0	10.5	2.5	M10 x 1.0
	DHBT-08L-M12	8	17.0	17.0	22.0	19.0	29.0	30.0	14.5	12.0	14.0	3.0	M12 x 1.5
	DHBT-10L-M14	10	19.0	19.0	22.0	19.0	30.0	30.0	15.5	12.0	14.0	3.0	M14 x 1.5
	DHBT-12L-M16	12	21.0	22.0	27.0	24.0	33.0	36.0	18.0	12.0	16.5	3.0	M16 x 1.5
	DHBT-15L-M18	15	23.0	27.0	30.0	27.0	36.0	39.5	20.5	12.0	18.5	3.0	M18 x 1.5
	DHBT-18L-M22	18	27.0	32.0	32.0	30.0	37.0	45.0	21.0	14.0	21.5	4.5	M22 x 1.5
PB 160	DHBT-22L-M26	22	31.0	36.0	41.0	36.0	44.0	53.0	27.5	16.0	24.0	3.5	M26 x 1.5
	DHBT-28L-M33	28	39.0	41.0	50.0	46.0	49.0	66.0	32.0	18.0	30.5	3.5	M33 x 2.0
	DHBT-35L-M42	35	49.0	50.0	60.0	55.0	58.0	76.0	36.0	20.0	35.5	3.5	M42 x 2.0
	DHBT-42L-M48	42	55.0	60.0	70.0	60.0	63.0	87.0	40.5	22.0	40.5	3.5	M48 x 2.0
S Heavy PB 400	DHBT-06S-M12	6	17.0	17.0	22.0	19.0	31.0	30.0	16.5	12.0	14.0	3.0	M12 x 1.5
	DHBT-08S-M14	8	19.0	19.0	22.0	19.0	31.0	30.0	16.5	12.0	14.0	3.0	M14 x 1.5
	DHBT-10S-M16	10	21.0	22.0	27.0	24.0	35.0	36.0	18.5	12.0	16.5	3.0	M16 x 1.5
	DHBT-12S-M18	12	23.0	24.0	30.0	27.0	36.0	39.5	20.0	12.0	18.5	3.0	M18 x 1.5
	DHBT-16S-M22	16	27.0	30.0	32.0	30.0	40.0	45.0	22.0	14.0	21.5	4.5	M22 x 1.5
	DHBT-20S-M27	20	32.0	36.0	41.0	36.0	48.0	53.0	26.5	16.0	24.0	3.5	M27 x 2.0
PB 250	DHBT-25S-M33	25	39.0	46.0	50.0	46.0	56.0	66.0	31.5	18.0	30.5	3.5	M33 x 2.0
	DHBT-30S-M42	30	49.0	50.0	60.0	55.0	64.0	76.0	37.0	20.0	35.5	3.5	M42 x 2.0
	DHBT-38S-M48	38	55.0	60.0	70.0	60.0	72.0	87.0	41.5	22.0	40.5	3.5	M48 x 2.0

- Dimensions and Drawings are for reference only and are subject to change without prior notice.
- Unless otherwise specified, all dimensions are in millimeters.
- Sizes, pressure classes, and end connections not listed are available upon request.
- Length given approximate figure with tightened nut.

DFGC-G (BSP Parallel)

Pressure Gauge Connector

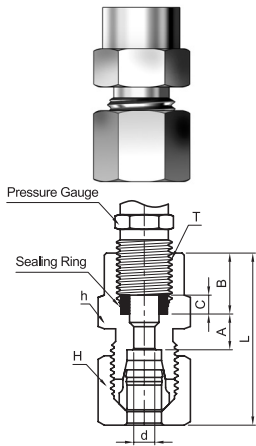

Series	Part No.	Tube O.D.	Dimension							
			d	H	h	L	A	B	C	T
L Light PN 315	DFGC-06L-02G	6	2.5	14.0	19.0	37.0	7.5	14.5	4.5	PF 1/4
	DFGC-08L-02G	8	5.5	17.0	19.0	37.0	7.5	14.5	4.5	PF 1/4
	DFGC-10L-02G	10	5.5	19.0	19.0	38.0	8.5	14.5	4.5	PF 1/4
	DFGC-12L-02G	12	5.5	22.0	19.0	38.0	8.5	14.5	4.5	PF 1/4
S Heavy PN 630	DFGC-06S-04G	6	3.5	17.0	27.0	46.0	11.0	20.0	5.0	PF 1/2
	DFGC-08S-04G	8	3.5	19.0	27.0	46.0	11.0	20.0	5.0	PF 1/2
	DFGC-10S-04G	10	7.0	22.0	27.0	47.0	10.5	20.0	5.0	PF 1/2
	DFGC-12S-04G	12	7.0	24.0	27.0	47.0	10.5	20.0	5.0	PF 1/2

DSGC-G (BSP Parallel)

Pressure Gauge Swivel Connector

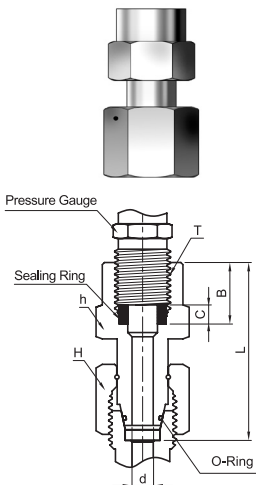

Series	Part No.	Tube O.D.	Dimension						
			d	H	h	L	B	C	T
L Light PN 315	DSGC-06L-02G	6	2.5	14.0	19.0	35.5	14.5	4.5	PF 1/4
	DSGC-08L-02G	8	4.0	17.0	19.0	35.5	14.5	4.5	PF 1/4
	DSGC-10L-02G	10	5.5	19.0	19.0	36.0	14.5	4.5	PF 1/4
	DSGC-12L-02G	12	5.5	22.0	19.0	36.0	14.5	4.5	PF 1/4
S Heavy PN 630	DSGC-06S-02G	6	2.5	17.0	19.0	35.5	14.5	4.5	PF 1/4
	DSGC-08S-02G	8	4.0	19.0	19.0	35.5	14.5	4.5	PF 1/4
	DSGC-10S-02G	10	6.0	22.0	19.0	36.0	14.5	4.5	PF 1/4
	DSGC-12S-02G	12	7.0	24.0	19.0	39.0	14.5	4.5	PF 1/4
	DSGC-06S-04G	6	2.5	17.0	27.0	42.5	20.0	5.0	PF 1/2
	DSGC-08S-04G	8	4.0	19.0	27.0	43.0	20.0	5.0	PF 1/2
	DSGC-10S-04G	10	6.0	22.0	27.0	43.5	20.0	5.0	PF 1/2
	DSGC-12S-04G	12	7.0	24.0	27.0	45.0	20.0	5.0	PF 1/2

DGAP-G (BSP Parallel)

Gauge Adaptor

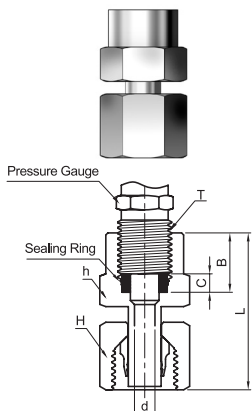

Series	Part No.	Tube O.D.	Dimension						
			d	H	h	L	B	C	T
L Light PN 315	DGAP-06L-02G	6	3.5	14.0	19.0	38.0	14.5	4.5	PF 1/4
	DGAP-08L-02G	8	5.5	17.0	19.0	38.0	14.5	4.5	PF 1/4
	DGAP-10L-02G	10	7.5	19.0	19.0	39.5	14.5	4.5	PF 1/4
	DGAP-12L-02G	12	9.0	22.0	19.0	40.5	14.5	4.5	PF 1/4
S Heavy PN 630	DGAP-06S-04G	6	3.5	17.0	27.0	45.0	20.0	5.0	PF 1/2
	DGAP-08S-04G	8	4.5	19.0	27.0	45.0	20.0	5.0	PF 1/2
	DGAP-10S-04G	10	6.5	22.0	27.0	47.0	20.0	5.0	PF 1/2
	DGAP-12S-04G	12	7.5	24.0	27.0	47.5	20.0	5.0	PF 1/2

- Dimensions and Drawings are for reference only and are subject to change without prior notice.
- Unless otherwise specified, all dimensions are in millimeters.
- Sizes, pressure classes, and end connections not listed are available upon request.
- Length given approximate figure with tightened nut.

DTPC

Tee Test Point Connector

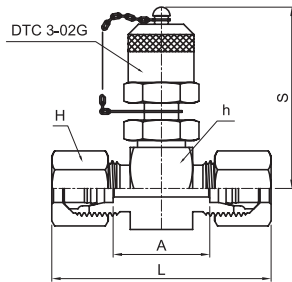
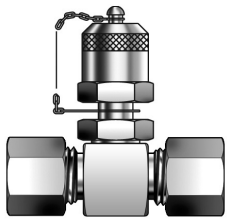

Series	Part No.	Tube O.D.	Dimension				
			H	h	L	A	S
L Light PN 315	DTPC 3-06L	6	14	24	50	20.5	50
	DTPC 3-08L	8	17	24	50	20.5	50
	DTPC 3-10L	10	19	24	52	22.5	50
	DTPC 3-12L	12	22	24	52	22.5	50
	DTPC 3-15L	15	27	30	55	24.5	53
	DTPC 3-18L	18	32	32	56	23.5	54
PB 160	DTPC 3-22L	22	36	36	60	27.5	56
	DTPC 3-28L	28	41	41	61	27.5	58
	DTPC 3-35L	35	50	46	69	25.5	61
	DTPC 3-42L	42	60	55	70	24.5	65
S Heavy PN 630	DTPC 3-06S	6	17	24	54	24.5	50
	DTPC 3-08S	8	19	24	54	24.5	50
	DTPC 3-10S	10	22	24	56	23.5	50
	DTPC 3-12S	12	24	24	56	23.5	50
	DTPC 3-14S	14	27	27	62	26.5	51
PN 400	DTPC 3-16S	16	30	30	62	25.5	53
	DTPC 3-20S	20	36	36	69	25.5	56
	DTPC 3-25S	25	46	41	75	26.5	58
PN 315	DTPC 3-30S	30	50	46	81	27.5	61
	DTPC 3-38S	38	60	55	90	29	65

DTC

Test Coupling

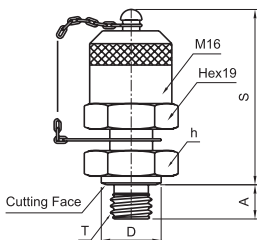
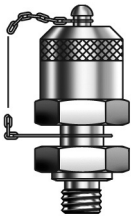

Series	Part No.	Dimension				
		h	D	S	A	T
PB 630	DTC 3-01G	17	14	41	8	PF 1/8
	DTC 3-02G	19	18	41	10	PF 1/4
	DTC 3-03G	22	22	41	12	PF 3/8
	DTC 3-04G	27	26	41	14	PF 1/2
	DTC 3-M10	17	14	41	8	M10 x 1.0
	DTC 3-M12	17	17	41	12	M12 x 1.5
	DTC 3-M14	19	19	41	12	M14 x 1.5
	DTC 3-M16	22	21	41	12	M16 x 1.5

- Dimensions and Drawings are for reference only and are subject to change without prior notice.
- Unless otherwise specified, all dimensions are in millimeters.
- Sizes, pressure classes, and end connections not listed are available upon request.
- Length given approximate figure with tightened nut.

DWC

Welding Connector

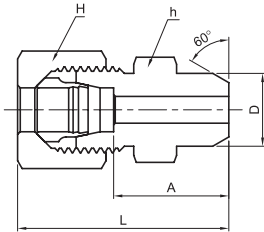
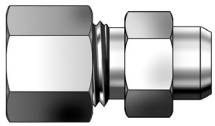

Series	Part No.	Tube O.D.	Dimension				
			D	H	h	L	A
L Light PN 315	DWC - 06L	6	10	14	12	29	14
	DWC - 08L	8	12	17	14	31	16
	DWC - 10L	10	14	19	17	33	18
	DWC - 12L	12	16	22	19	33	18
	DWC - 15L	15	19	27	22	37	22
	DWC - 18L	18	22	32	27	40	23.5
PB 160	DWC - 22L	22	27	36	32	45	28.5
	DWC - 28L	28	32	41	41	47	30.5
	DWC - 35L	35	40	50	46	54	32.5
	DWC - 42L	42	46	60	55	58	35
S Heavy PN 630	DWC - 06S	6	11	17	14	34	19
	DWC - 08S	8	13	19	17	36	21
	DWC - 10S	10	15	22	19	39	22.5
	DWC - 12S	12	17	24	22	41	24.5
	DWC - 14S	14	19	27	24	45	27
PN 400	DWC - 16S	16	21	30	27	45	26.5
	DWC - 20S	20	26	36	32	51	29.5
	DWC - 25S	25	31	46	41	56	32
	DWC - 30S	30	36	50	46	62	35.5
PN 315	DWC - 38S	38	44	60	55	69	38

DAWC

Welding Connector with DWN

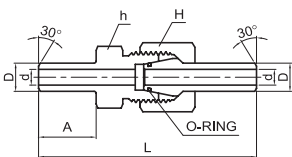
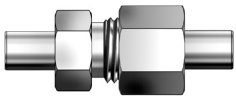

Series S MAX. Pressure	Part No.	Tube O.D.	Dimension				
			d	H	h	L	A
PB248	DAWC-10 x 1.0		8				
PB357	DAWC-10 x 1.5	10	7	22	19	58	10
PB458	DAWC-10 x 2.0		6				
PB303	DAWC-12 x 1.5		9				
PB391	DAWC-12 x 2.0	12	8	24	22	65	15
PB474	DAWC-12 x 2.5		7				
PB234	DAWC-16 x 1.5		13				
PB303	DAWC-16 x 2.0		12				
PB370	DAWC-16 x 2.5	16	11	30	27	74.5	16.5
PB433	DAWC-16 x 3.0		10				
PB249	DAWC-20 x 2.0		16				
PB305	DAWC-20 x 2.5		15				
PB357	DAWC-20 x 3.0	20	14	36	32	84	19
PB458	DAWC-20 x 4.0		12				
PB292	DAWC-25 x 3.0		19				
PB378	DAWC-25 x 4.0	25	17	46	41	94.5	19.5
PB458	DAWC-25 x 5.0		15				
PB248	DAWC-30 x 3.0		24				
PB321	DAWC-30 x 4.0		22				
PB391	DAWC-30 x 5.0	30	20	50	46	102	23
PB460	DAWC-30 x 6.0		18				
PB260	DAWC-38 x 4.0		30				
PB318	DAWC-38 x 5.0		28				
PB373	DAWC-38 x 6.0	38	26	60	55	111	23
PB427	DAWC-38 x 7.0		24				

- Dimensions and Drawings are for reference only and are subject to change without prior notice.
- Unless otherwise specified, all dimensions are in millimeters.
- Sizes, pressure classes, and end connections not listed are available upon request.
- Length given approximate figure with tightened nut.

DWN

Welding Nipple

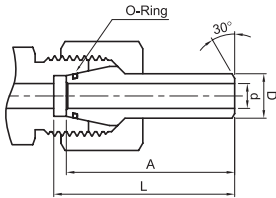
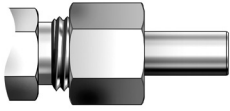

Pressure Rating		Part No.	Tube OD		Dimension		
Fittings	DWN and Tube		D	d	L	A	
PN630	PB 248	DWN-10 x 1.0	10	8	35.5	33	
	PB 357	DWN-10 x 1.5		7			
	PB 458	DWN-10 x 2.0		6			
PN630	PB 303	DWN-12 x 1.5	12	9	35.5	33	
	PB 391	DWN-12 x 2.0		8			
	PB 474	DWN-12 x 2.5		7			
PN400	PB 234	DWN-16 x 1.5	16	13	42.5	39	
	PB 303	DWN-16 x 2.0		12			
	PB 370	DWN-16 x 2.5		11			
PN400	PB 433	DWN-16 x 3.0	20	10	47.5	43.5	
	PB 249	DWN-20 x 2.0		16			
	PB 303	DWN-20 x 2.5		15			
PN400	PB 357	DWN-20 x 3.0	25	14	55	49.5	
	PB 458	DWN-20 x 4.0		12			
	PB 292	DWN-25 x 3.0		19			
PN400	PB 378	DWN-25 x 4.0	30	17	58.5	51.5	
	PB 458	DWN-25 x 5.0		15			
	PB 248	DWN-30 x 3.0		24			
	PB 321	DWN-30 x 4.0		22			
PN315	PB 391	DWN-30 x 5.0	38	20	66	56.5	
	PB 460	DWN-30 x 6.0		18			
	PB 260	DWN-38 x 4.0		30			
	PB 318	DWN-38 x 5.0		28			
PN315	PB 373	DWN-38 x 6.0	38	26	66	56.5	
	PB 427	DWN-38 x 7.0		24			

DRWN

Reducing Welding

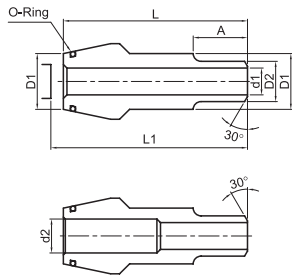
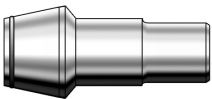

Pressure Rating		Part No.	Tube OD		Dimension				
Fittings	DWN and Tube		D1	D2	d1	d2	L1	L	A
PN630	PB 526	DRWN-10- 6 x 1.5	10	6	3	5	37.5	35	12
	PB 526	DRWN-10- 8 x 2.0	10	8	4	-	37.5	35	12
	PB 526	DRWN-12- 8 x 2.0	12	8	4	6	37.5	35	14
	PB 357	DRWN-12-10 x 1.5	12	10	7	-	37.5	35	14
PN400	PB 474	DRWN-16-12 x 2.5	16	12	7	-	46.5	43	15
	PB 474	DRWN-20-12 x 2.5	20	12	7	-	51.5	47.5	15
	PB 433	DRWN-20-16 x 3.0	20	16	10	-	53.5	49.5	17
	PB 433	DRWN-25-16 x 3.0	25	16	10	-	56.5	51	17
	PB 458	DRWN-25-20 x 4.0	25	20	12	-	59.5	54	20
	PB 303	DRWN-30-16 x 2.0	30	16	12	-	67	60	17
	PB 303	DRWN-30-20 x 2.5	30	20	15	-	70	63	20
	PB 292	DRWN-30-25 x 3.0	30	25	19	-	70	63	20
PN315	PB 303	DRWN-38-16 x 2.0	38	16	12	-	79	69.5	17
	PB 303	DRWN-38-20 x 2.5	38	20	15	-	82	72.5	20
	PB 292	DRWN-38-25 x 3.0	38	25	19	-	82	72.5	20
	PB 321	DRWN-38-30 x 4.0	38	30	22	-	82	72.5	20

- Dimensions and Drawings are for reference only and are subject to change without prior notice.
- Unless otherwise specified, all dimensions are in millimeters.
- Sizes, pressure classes, and end connections not listed are available upon request.
- Length given approximate figure with tightened nut.

DMFC

Male Female Connector

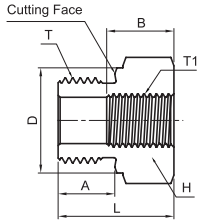
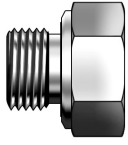

BSP Parallel Thread Type

Series	Part No.	Dimension							
		H	D	L	A	B	T	T1	
PB 630	DMFC-03G-01G	22	22	22.5	12	8	PF 3/8	PF 1/8	
PB 630	DMFC-04G-01G	27	26	24	14	8	PF 1/2	PF 1/8	
PB 400	DMFC-04G-02G	27	26	24	14	12	PF 1/2	PF 1/4	
PB 400	DMFC-06G-02G	32	32	26	16	12	PF 3/4	PF 1/4	
	DMFC-06G-03G	32	32	26	16	12	PF 3/4	PF 3/8	
PB 400	DMFC-08G-02G	41	39	29	18	12	PF1	PF 1/4	
	DMFC-08G-03G	41	39	29	18	12	PF1	PF 3/8	
	DMFC-08G-04G	41	39	29	18	14	PF1	PF 1/2	
PB 250	DMFC-10G-04G	50	49	32	20	14	PF 1-1/4	PF 1/2	
	DMFC-10G-06G	50	49	32	20	16	PF 1-1/4	PF 3/4	
PB 250	DMFC-12G-04G	55	55	36	22	14	PF 1-1/2	PF 1/2	
	DMFC-12G-06G	55	55	36	22	16	PF 1-1/2	PF 3/4	
	DMFC-12G-08G	55	55	36	22	18	PF 1-1/2	PF 1	

* ISO/BSP parallel gaskets are available. See the Last Page.

DMFG

Male Female Gauge Connector

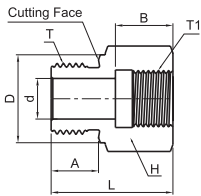

BSP Parallel Thread Type

Series	Part No.	Dimension							
		H	d	D	L	A	B	T	T1
PB 630	DMFG-01G-02G	19	4	14	31	8	17	PF 1/8	PF 1/4
	DMFG-01G-03G	24	4	14	32	8	17	PF 1/8	PF 3/8
	DMFG-02G-01G	19	5	18	28	12	12	PF 1/4	PF 1/8
	DMFG-02G-03G	24	5	18	36	12	17	PF 1/4	PF 3/8
	DMFG-02G-04G	30	5	18	40	12	20	PF 1/4	PF 1/2
PB 400	DMFG-02G-06G	36	5	18	43	12	22	PF 1/4	PF 3/4
PB 630	DMFG-03G-02G	22	8	22	36	12	17	PF 3/8	PF 1/4
	DMFG-03G-04G	30	8	22	41	12	20	PF 3/8	PF 1/2
PB 250	DMFG-03G-06G	36	8	22	44	12	22	PF 3/8	PF 3/4
PB 400	DMFG-04G-03G	27	12	26	36	14	17	PF 1/2	PF 3/8
	DMFG-04G-06G	36	12	26	46	14	22	PF 1/2	PF 3/4
	DMFG-04G-08G	41	12	26	49	14	24.5	PF 1/2	PF 1
PB 250	DMFG-04G-10G	55	10	26	53	14	26.5	PF 1/2	PF 1-1/4
PB 400	DMFG-06G-04G	32	16	32	41	16	20	PF 3/4	PF 1/2
	DMFG-06G-08G	41	16	32	51	16	24.5	PF 3/4	PF 1
	DMFG-06G-10G	55	16	32	55	16	26.5	PF 3/4	PF 1-1/4
PB 250	DMFG-06G-12G	60	16	32	57	16	28.5	PF 3/4	PF 1-1/2
PB 400	DMFG-08G-06G	41	20	39	47	18	22	PF 1	PF 3/4
PB 250	DMFG-08G-10G	55	20	39	57	18	26.5	PF 1	PF 1-1/4
	DMFG-08G-12G	60	20	39	59	18	28.5	PF 1	PF 1-1/2
	DMFG-10G-08G	50	25	49	52	20	24.5	PF 1-1/4	PF 1
	DMFG-10G-12G	60	25	49	60	20	28.5	PF 1-1/4	PF 1-1/2
	DMFG-12G-10G	55	32	55	58	22	26.5	PF 1-1/2	PF 1-1/4
	DMFG-16G-12G	70	40	68	62	24	28.5	PF 2	PF 1-1/2

* ISO/BSP parallel gaskets are available. See the Last Page.

- Dimensions and Drawings are for reference only and are subject to change without prior notice.
- Unless otherwise specified, all dimensions are in millimeters.
- Sizes, pressure classes, and end connections not listed are available upon request.
- Length given approximate figure with tightened nut.

DMFC-ED

Male Female Connector with ED-Ring

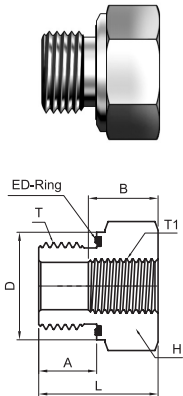

BSP Parallel Thread Type

Series	Part No.	Dimension						
		H	D	L	A	B	T	T1
PB 630	DMFC-03ED-01G	22	22	22.5	12	8	PF 3/8	PF 1/8
PB 630	DMFC-04ED-01G	27	26	24	14	8	PF 1/2	PF 1/8
PB 400	DMFC-04ED-02G	27	26	24	14	12	PF 1/2	PF 1/4
PB 400	DMFC-06ED-02G	32	32	26	16	12	PF 3/4	PF 1/4
	DMFC-06ED-03G	32	32	26	16	12	PF 3/4	PF 3/8
PB 400	DMFC-08ED-02G	41	39	29	18	12	PF1	PF 1/4
	DMFC-08ED-03G	41	39	29	18	12	PF1	PF 3/8
	DMFC-08ED-04G	41	39	29	18	14	PF1	PF 1/2
PB 250	DMFC-10ED-04G	50	49	32	20	14	PF 1-1/4	PF 1/2
	DMFC-10ED-06G	50	49	32	20	16	PF 1-1/4	PF 3/4
PB 250	DMFC-12ED-04G	55	55	36	22	14	PF 1-1/2	PF 1/2
	DMFC-12ED-06G	55	55	36	22	16	PF 1-1/2	PF 3/4
	DMFC-12ED-08G	55	55	36	22	18	PF 1-1/2	PF1

DMFG-ED

Male Female Gauge Connector with ED-Ring

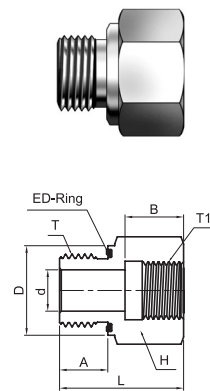

BSP Parallel Thread Type

Series	Part No.	Dimension							
		H	d	D	L	A	B	T	T1
PB 630	DMFG-01ED-02G	19	4	14	31	8	17	PF 1/8	PF 1/4
	DMFG-01ED-03G	24	4	14	32	8	17	PF 1/8	PF 3/8
	DMFG-02ED-01G	19	5	18	28	12	12	PF 1/4	PF 1/8
	DMFG-02ED-03G	24	5	18	36	12	17	PF 1/4	PF 3/8
PB450	DMFG-02ED-04G	30	5	18	40	12	20	PF 1/4	PF 1/2
	DMFG-02ED-06G	36	5	18	43	12	22	PF 1/4	PF 3/4
PB 630	DMFG-03ED-02G	22	8	22	36	12	17	PF 3/8	PF 1/4
	DMFG-03ED-04G	30	8	22	41	12	20	PF 3/8	PF 1/2
PB400	DMFG-03ED-06G	36	8	22	44	12	22	PF 3/8	PF 3/4
PB400	DMFG-04ED-03G	27	12	26	36	14	17	PF 1/2	PF 3/8
	DMFG-04ED-06G	36	12	26	46	14	22	PF 1/2	PF 3/4
	DMFG-04ED-08G	41	12	26	49	14	24.5	PF 1/2	PF 1
PB250	DMFG-04ED-10G	55	10	26	53	14	26.5	PF 1/2	PF 1-1/4
PB400	DMFG-06ED-04G	32	16	32	41	16	20	PF 3/4	PF 1/2
	DMFG-06ED-08G	41	16	32	51	16	24.5	PF 3/4	PF 1
	DMFG-06ED-10G	55	16	32	55	16	26.5	PF 3/4	PF 1-1/4
PB250	DMFG-06ED-12G	60	16	32	57	16	28.5	PF 3/4	PF 1-1/2
PB400	DMFG-08ED-06G	41	20	39	47	18	22	PF 1	PF 3/4
	DMFG-08ED-10G	55	20	39	57	18	26.5	PF 1	PF 1-1/4
	DMFG-08ED-12G	60	20	39	59	18	28.5	PF 1	PF 1-1/2
	DMFG-10ED-08G	50	25	49	52	20	24.5	PF 1-1/4	PF 1
	DMFG-10ED-12G	60	25	49	60	20	28.5	PF 1-1/4	PF 1-1/2
	DMFG-12ED-10G	55	32	55	58	22	26.5	PF 1-1/2	PF 1-1/4
PB250	DMFG-16ED-12G	70	40	68	62	24	28.5	PF 2	PF 1-1/2

- Dimensions and Drawings are for reference only and are subject to change without prior notice.
- Unless otherwise specified, all dimensions are in millimeters.
- Sizes, pressure classes, and end connections not listed are available upon request.
- Length given approximate figure with tightened nut.

DC
Tube Cap

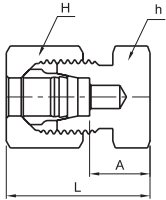
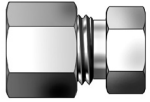

Series	Part No.	Tube O.D.	Dimension			
			H	h	L	A
L Light PN 315	DC-06L	6	14	12	22	7.0
	DC-08L	8	17	14	23	8.0
	DC-10L	10	19	17	24	9.0
	DC-12L	12	22	19	25	10.0
	DC-15L	15	27	24	26	11.0
	DC-18L	18	32	27	28	11.5
PN 160	DC-22L	22	36	32	30	13.5
	DC-28L	28	41	41	31	14.5
	DC-35L	35	50	46	36	14.5
	DC-42L	42	60	55	39	16.0
S Heavy PN 630	DC-06S	6	17	14	26	11.0
	DC-08S	8	19	17	28	13.0
	DC-10S	10	22	19	29	12.5
	DC-12S	12	24	22	31	14.5
	DC-14S	14	27	24	34	16.0
PN 400	DC-16S	16	30	27	34	15.5
	DC-20S	20	36	32	39	17.5
	DC-25S	25	46	41	44	20.0
	DC-30S	30	50	46	47	20.5
PN 315	DC-38S	38	60	55	54	23.0

DP
Plug

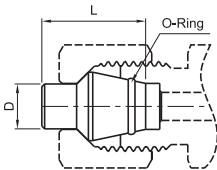
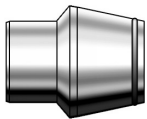

Series	Part No.	Tube O.D.	Dimension	
			D	L
L Light PN 315	DP-06LS	6	6	18.5
	DP-08LS	8	8	18.5
	DP-10LS	10	10	20
	DP-12LS	12	12	20.5
	DP-15L	15	15	20.5
	DP-18L	18	18	22.5
PN 160	DP-22L	22	22	25
	DP-28L	28	28	25.5
	DP-35L	35	35	30
	DP-42L	42	42	30
S Heavy PN 630	DP-14S	14	14	22.5
PN 400	DP-16S	16	16	23.5
	DP-20S	20	20	28.5
	DP-25S	25	25	29
	DP-30S	30	30	30.5
PN 315	DP-38S	38	38	33

- Dimensions and Drawings are for reference only and are subject to change without prior notice.
- Unless otherwise specified, all dimensions are in millimeters.
- Sizes, pressure classes, and end connections not listed are available upon request.
- Length given approximate figure with tightened nut.

DBP-GED/MED(BSP Parallel/Metric Parallel)

Blanking Plugs for Port with ED-Ring

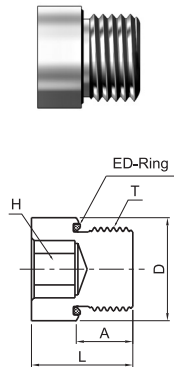

Series	Part No.	T		Dimension			
		M(Metric)	G(PF)	D	H	L	A
PB 400	DBP-01GED	M10 x 1.0	1/8	14.0	5	12.0	8
	-	M12 x 1.5	-	17.0	6	17.0	12
	DBP-02GED	M14 x 1.5	1/4	19.0	6	17.0	12
	DBP-03GED	M16 x 1.5	3/8	22.0	8	17.0	12
	-	M18 x 1.5	-	23.9	8	17.0	12
	-	M20 x 1.5	-	25.9	10	19.0	14
	DBP-04GED	M22 x 1.5	1/2	27.0	10	19.0	14
	-	M26 x 1.5	-	31.9	12	21.0	16
	DBP-06GED	M27 x 2.0	3/4	32.0	12	21.0	16
	DBP-08GED	M33 x 2.0	1	39.9	17	22.5	16
PB 250	DBP-10GED	M42 x 2.0	1 1/4	49.9	22	22.5	16
	DBP-12GED	M48 x 2.0	1-1/2	55.0	24	22.5	16

DBP-M (Metric Parallel)

Blanking Plugs with O-Ring

(accord.to ISO 6149-3/DIN 3582)

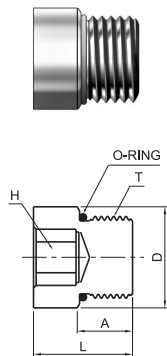

Series	Part No.	T M(Metric)	Dimension			
			D	H	L	A
PB 630	DBP-M10	M10 x 1	13	5	14	10
	DBP-M12	M12 x 1.5	17	6	16.5	11.5
	DBP-M14	M14 x 1.5	19	6	16.5	11.5
	DBP-M16	M16 x 1.5	21	6	18	13
	DBP-M18	M18 x 1.5	23	8	19.5	14.5
	DBP-M22	M22 x 1.5	27	10	20.5	15.5
	DBP-M26	M26 x 1.5	31	12	21	16
	DBP-M27	M27 x 2	32	12	24	19
	DBP-M33	M33 x 2	38	17	25.5	19
	DBP-M42	M42 x 2	48	22	26	19.5

- Dimensions and Drawings are for reference only and are subject to change without prior notice.
- Unless otherwise specified, all dimensions are in millimeters.
- Sizes, pressure classes, and end connections not listed are available upon request.
- Length given approximate figure with tightened nut.

Tube End Dimension

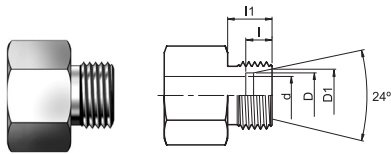

DNT NUT

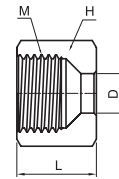

DCR

Cutting Ring

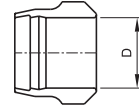

Series	Nut Part No.	Cutting Ring Part No.	Tube O.D.	DN Size	Dimension							
					D	D1	d	H	L	M	I	I1
LL Very Light	DNT-04LL	DCR-04LL	4	3	4	5	3	10	11.5	M8 x 1.0	4	8
	DNT-06LL	DCR-06LL	6	4	6	7.5	4.5	12	12	M10 x 1.0	5.5	8
	DNT-08LL	DCR-08LL	8	6	8	9.5	6	14	12.5	M12 x 1.0	5.5	9
	DNT-10LL	DCR-10LL	10	8	10	11.5	8	17	12.5	M14 x 1.0	6	9
	DNT-12LL	DCR-12LL	12	10	12	13.5	10	19	13	M16 x 1.0	6	9
L Light	DNT-06L	DCR-06L	6	4	6	8.1	4	14	15	M12 x 1.5	7	10
	DNT-08L	DCR-08L	8	6	8	10.1	6	17	15	M14 x 1.5	7	10
	DNT-10L	DCR-10L	10	8	10	12.3	8	19	16	M16 x 1.5	7	11
	DNT-12L	DCR-12L	12	10	12	14.3	10	22	16	M18 x 1.5	7	11
	DNT-15L	DCR-15L	15	12	15	17.3	12	27	17.5	M22 x 1.5	7	12
	DNT-18L	DCR-18L	18	16	18	20.3	15	32	18	M26 x 1.5	7.5	12
	DNT-22L	DCR-22L	22	20	22	24.3	19	36	20.5	M30 x 2.0	7.5	14
	DNT-28L	DCR-28L	28	25	28	30.3	24	41	21	M36 x 2.0	7.5	14
	DNT-35L	DCR-35L	35	32	35	38	30	50	24	M45 x 2.0	10.5	16
DNT-42L	DCR-42L	42	40	42	45	36	60	24	M52 x 2.0	11	16	
S Heavy	DNT-06S	DCR-06S	6	3	6	8.1	4	17	16.5	M14 x 1.5	7	12
	DNT-08S	DCR-08S	8	4	8	10.1	5	19	16.5	M16 x 1.6	7	12
	DNT-10S	DCR-10S	10	6	10	12.3	7	22	17.5	M18 x 1.5	7.5	12
	DNT-12S	DCR-12S	12	8	12	14.3	8	24	18	M22 x 1.5	7.5	12
	DNT-14S	DCR-14S	14	10	14	16.3	10	27	20.5	M22 x 1.5	8	14
	DNT-16S	DCR-16S	16	12	16	18.3	12	30	21	M24 x 1.5	8.5	14
	DNT-20S	DCR-20S	20	16	20	22.9	16	36	24	M30 x 2.0	10.5	16
	DNT-25S	DCR-25S	25	20	25	27.9	20	46	27	M36 x 2.0	12	18
	DNT-30S	DCR-30S	30	25	30	33	25	50	29.5	M42 x 2.0	13.5	20
DNT-38S	DCR-38S	38	32	38	41	32	60	32.5	M52 x 2.0	16	22	

DED

ED-Ring

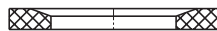

Part No.	For Male Thread	
	Metric (ISO 261)	ISO 228/1
DED- M8	M8 x 1.0	-
DED-M10	M10 x 1.0	PF 1/8
DED-M12	M12 x 1.5	-
DED-M14	M14 x 1.5	PF 1/4
DED-M16	M16 x 1.5	-
DED-03G	-	PF 3/8
DED-M18	M18 x 1.5	-
DED-M20	M20 x 1.5	-
DED-04G	-	PF 1/2
DED-M22	M22 x 1.5	--
DED-M26	M26 x 1.5	-
DED-M27	M27 x 2.0	PF 3/4
DED-M33	M33 x 2.0	PF 1
DED-M42	M42 x 2.0	PF 1-1/4
DED-M48	M48 x 2.0	PF 1-1/2

DOR

O-Ring

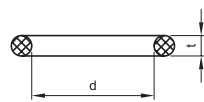

Part No.	For Male Thread	
	d	t
DOR-4	4	1.5
DOR-6	6	1.5
DOR-7.5	7.5	1.5
DOR-9	9	1.5
DOR-10	10	2.0
DOR-12	12	2.0
DOR-15	15	2.0
DOR-16.3	16.3	2.4
DOR-20	20	2
DOR-20.3	20.3	2.4
DOR-25.3	25.3	2.4
DOR-26	26	2
DOR-32	32	2.5
DOR-33.3	33.3	2.4
DOR-38	38	2.5

- Dimensions and Drawings are for reference only and are subject to change without prior notice.
- Unless otherwise specified, all dimensions are in millimeters.
- Sizes, pressure classes, and end connections not listed are available upon request.
- Length given approximate figure with tightened nut.

ISO/BSP Parallel Gaskets

IBG Gasket

Steel and Stainless Steel

IBG provides a seal with male ISO/BSP parallel threads. The IBG gasket is a NBR or VITON inner ring bonded to a stainless steel or carbon steel outer ring as recommended in DIN 3852. It can be used with end connections designed in accordance with ISO 228 / DIN 3852 Part 2.

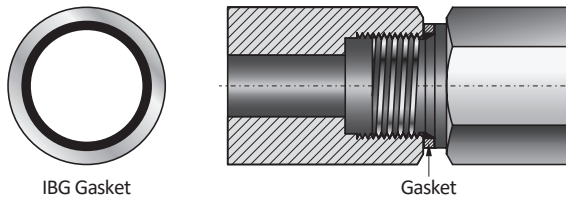

IPG Gasket

Copper and Stainless Steel

IPG provides a seal with male ISO/BSP parallel threads. The IPG gasket is an all-metal 316 stainless steel or Copper gasket. It can be used with end connections designed in accordance with ISO 228 / DIN 3852 Part 2.

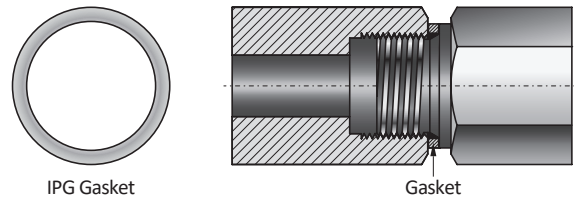

Ordering Information

Example : **IBG - 8 - 01**

1
2

1. Size of Gasket

Tube OD(inch)	1/4	3/8	1/2	3/4	1
Designator	4	6	8	12	16

2. Material

- 01 = SUS316 + NBR
- 02 = CARBON + NBR
- 03 = SUS316 + VITON

3. IBG Part Number

ISO Thread Size (inch)	Material		
	01	02	03
1/4	IBG-4-01	IBG-4-02	IBG-4-03
3/8	IBG-6-01	IBG-6-02	IBG-6-03
1/2	IBG-8-01	IBG-8-02	IBG-8-03
3/4	IBG-12-01	IBG-12-02	IBG-12-03
1	IBG-16-01	IBG-16-02	IBG-16-03

Ordering Information

Example : **IPG - 8 - CU**

1
2

1. Size of Gasket

Tube OD(inch)	1/4	3/8	1/2	3/4	1
Designator	4	6	8	12	16

2. Material

- (Blank) = SUS316
- CU = Copper

3. IPG Part Number

ISO Thread Size (inch)	Material	
	(Blank)	CU
1/4	IPG-4	IPG-4-CU
3/8	IPG-6	IPG-6-CU
1/2	IPG-8	IPG-8-CU
3/4	IPG-12	IPG-12-CU
1	IPG-16	IPG-16-CU

Memo



BMT Co., Ltd.

Headquarters

(46031) 부산시 기장군 장안읍 신소재산단2로 17 (반룡리)

17, Sinsojaesandan 2-ro, Jangan-eup, Gijang-gun, Busan, 46031 South Korea

TEL: +82 51 780 5000 FAX: +82 51 780 5100

E-mail: superlok@superlok.com

WEB: www.superlok.com

Fittings & Valves

Industrial

Instrumentation Tube Fittings

i-Fitting®

Ball/Plug Valves

Double Block & Bleed Valves

Manifold/Gauge Valves

Globe/Needle Valves

Cryogenic Valves

Check/Relief/Excess Flow Valves

Medium/High Pressure Fittings & Valves

Eco-fuel Conversion and Supply Units

Ultra High Purity

HGB® (High-integrated Gas Box)

HGS® (High-integrated Gas System)

Weld & Metal Face Seal Fittings

Bend Fittings

Diaphragm Valves

Bellows Valves

Check Valves

Clean Ball Valves

Regulators

Gas Filters

HGB® : Trademark registered in Republic of Korea, Japan and United States (as of August 2025)

HGS® : Trademark registered in Republic of Korea, Japan and United States (as of May 2025)

Electric & Energy

Metal Clad Switchgear (MCSG)

Compact Switchboard

Motor Control Center (MCC)

Smart Distribution Board

Energy Management System (EMS)