

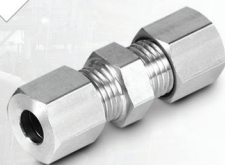

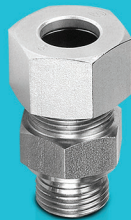

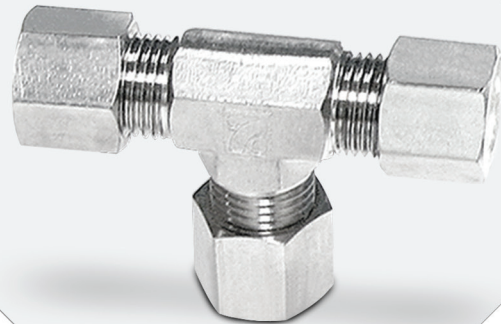

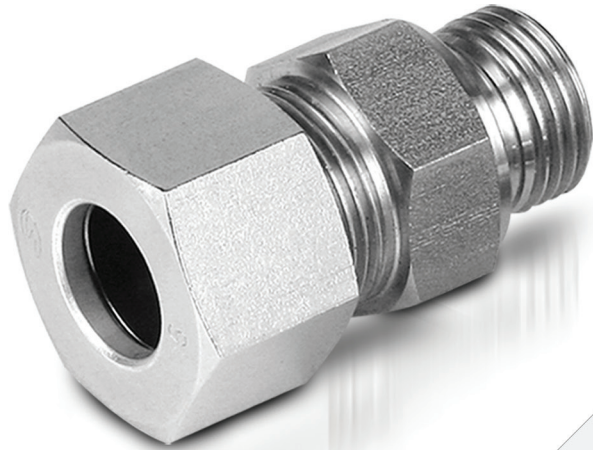

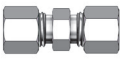







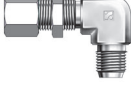

























SUPERLOK JIS Tube Fitting (JIS B2351 Bite-type)

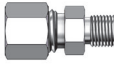

SUPERLOK JIS Tube Fitting Index

	BUS Straight Union	6P		BMRT Male Run Tee	16P		BHME Hose Male Elbow	24P
	BUE Union Elbow	6P		BCF Female Connector	17P		BHFE Hose Female Elbow	24P
	BUT Union Tee	7P		BBCF Bulkhead Female Connector	17P		BHBME Hose Bulkhead Male Elbow	25P
	BUC Union Cross	7P		BFGC Female Gauge Connector	18P		BHBFE Hose Bulkhead Female Elbow	25P
	BBHU Bulkhead Union	8P		BFE Female Elbow	18P		BWC Welding Connector	26P
	BBUE Bulkhead Union Elbow	8P		BFBT Female Branch Tee	19P		BWBU Welding Bulkhead Union	26P
	BCM-R Male Connector	9P		BFRT Female Run Tee	19P		BAP-R Adapter	27P
	BCM-G Male Connector (For Copper Gasket)	10P		BC Cap	20P		BAP-G Adapter	27P
	BCM-GO Male Connector (For O-Ring)	11P		BPL Plug	20P		BRD Reducer	28P
	BLCM Long Male Connector	12P		BNT Nut	21P		BAE Adjustable Elbow	28P
	BME Male Elbow	13P		BCR Sleeve	21P		BABT Adjustable Branch Tee	29P
	BLME Long Male Elbow	14P		BHMU Hose Male Union	22P		BART Adjustable Run Tee	29P
	BPME Positionable Male Elbow	14P		BHFU Hose Female Union	22P		BAPV Air Purge Valve (Tube End)	30P
	BBE Banjo Elbow	15P		BHBMU Hose Bulkhead Male Union	23P		BAPV-R Air Purge Valve (Thread End)	30P
	BMBT Male Branch Tee	15P		BHBFU Hose Bulkhead Female Union	23P			

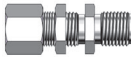
Design and Construction

SUPERLOK JIS Tube Fitting is manufactured to JIS B2351& KS B1535 under strict ISO 9001 procedure.

This fitting consists of three parts : BODY, SLEEVE and NUT, and is designed to work over medium and heavy wall tubing. See Fig.1

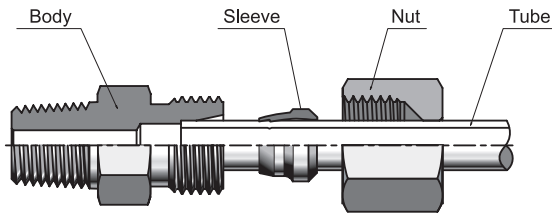

Fig.1

When tightening nut, sleeve is driven forward on the tube. The sleeve then bites into the tube causing a small ridge of tube material to be pushed up in front of the biting edge of the sleeve. See Fig.2

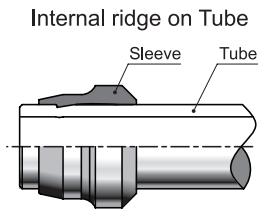

Fig.2

The make up of the fitting is critical in that the tube must be bottomed against the tube stop in the body or presetting tool during make up. If it is not bottomed, the tube will move forward with the sleeve and a bite will not be achieved. Make sure the tube is bottomed. A check is possible to see if the tube was bottomed during make up. To make this check look at the end of the tube, and notice if a circular appearing ring has been impressed into the tube end face. This impression will be caused by the tube stop which has a slight reverse angle rather than a flat face.

Pressure Range & Working Temperature

Material		Carbon Steel	Stainless Steel	Brass
Pressure (Kgf/cm ²)	O.D (mm)	4-15	500	250
		16-22	400	210
		25-28	350	170
		30-38	250	150
		40-50	210	120
Temperature		-40°C to 120°C (DIN 3859)	-60°C to 400°C (DIN 17440)	-60°C to 175°C

Material Specifications

Parts	Carbon Steel	Stainless Steel	Brass
Forged Body	JIS G4051 S20C-S48C	SUS316, SUS304	JIS H3250 C3771
Bar Stock Body	JIS G4051 S20C-S48C	SUS316, SUS304	JIS H3250 C3604
Cold Formed Nut	JIS G4051 S10C-S20C		
Bar Stock Nut	JIS G4051 S20C-S48C	SUS316, SUS304	JIS H3250 C3604
Sleeve	JIS G4051 S10C	SUS316, SUS304	JIS H3250 C3604

Tubing Selection

Carbon Steel

Seamless, welded, fully annealed and redrawn tube suitable for bending with maximum hardness Rockwell B72.

Stainless Steel

Seamless, welded, fully annealed and redrawn tube suitable for bending with maximum hardness Rockwell B90

Copper

For seamless coils, soft or light annealed, maximum hardness Rockwell F55.

For straight lengths, light drawn and general purpose, maximum hardness 60 on Rockwell 30T scale.

Assembly Instructions

Step 1. Cutting the tube :

Cut tube squarely and lightly deburr the end internally and externally.

Step 2. Sleeve placement :

Set a nut and sleeve on the tube. Make sure the sleeve and the nut are facing the fitting.

Step 3. Lubrication :

Lightly lubricate threads on tool or body as well as the tail and lead end of the sleeve with an extreme friction lubricant.

Step 4. Pre-setting :

Insert tube end into tool or fitting until it bottoms against the shoulder (to hold tube motionless during pre-setting operation) and screw nut down finger tight.

Step 5. Final setting :

Wrench nut down 1-1/2 turns to pre-set the sleeve. Reliable make up of all flareless tube fittings is dependent upon the sleeve traveling a prescribed distance into the tapered fitting throat in order to bite into the tube and effect a positive grip and seal.

Reassembly Instructions

Fitting can be used many times. To ensure this, parts must be clean and free of defects.

Step 1. Insert the tube into fitting body until sleeve seats firmly in the fitting and hand-tighten the nut.

Step 2. Tighten the nut with a wrench by holding the fitting body with a backup wrench until a sharp rise in torque is felt. Further tighten the nut 1/4 to 1/2 turn.

Pre-Set Inspection

All SUPERLOK JIS Tube Fitting presets must be disassembled and inspected for proper sleeve pre-set before final installation for service. The following detailed inspection procedures must be followed regardless of the method used to pre-set the sleeve to the tube. (See Fig.3)

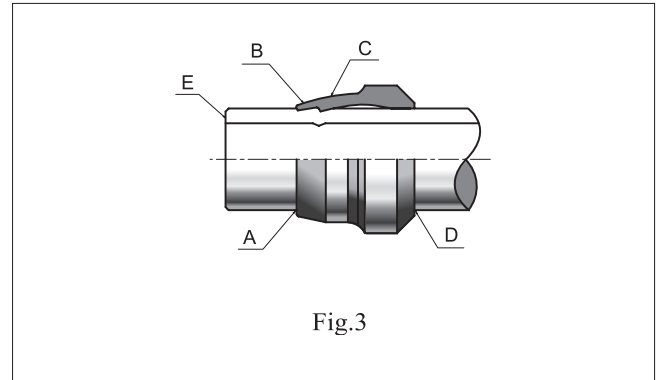

Fig.3

1. A ridge of metal (A) has been raised above the tube surface to a height of at least 50% of the thickness of the sleeve leading edge, completely around the tube.
2. While the leading edge of the sleeve may be coined flat (B) there is a slight bow to the balance of the pilot section (C).
3. The tail or back end of the sleeve is snug against the tube (D).
4. There is a slight indentation around the end of the tube (E) that indicates the tube was bottomed in the tool or fitting during pre-setting (if evidence of this complete contact is not visible the sleeve may not be properly pre-set).
5. Avoid rotating the sleeve. Steel sleeve should not be capable of moving back and forth along the tube beyond the bite area (a stainless steel sleeve will move more than steel because of its spring back characteristics).

Trouble Shooting Guide

Most problems with bite type fittings are traced to faulty Pre-Set/Assembly procedure.

1. Tube not bottomed

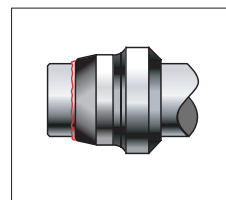

Remedy:

Check for the indentation on the tube end or compare the length from the end of the tube to the front end of the sleeve of a known good assembly to that of the assembly in question. This assembly should be scrapped.

2. Shallow bite

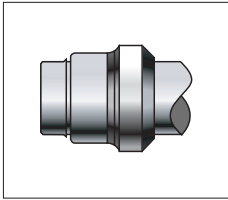

Remedy:
Inspect for turned up ridge of material. A failure to achieve this ridge can be traced either to the nut not being tightened enough or the tube not being bottomed against the stop which allowed the tube to travel forward with the sleeve. In some instances this assembly may be re-worked.

3. Over-set sleeve

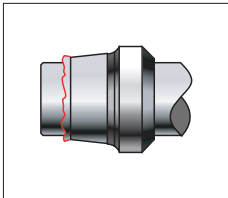

Remedy:
Too much pressure or more than 1-3/4 turns from finger tight were used to pre-set sleeve, or the nut was severely over-tightened in final assembly. This assembly should be scrapped.

4. Sleeve cocked on tube

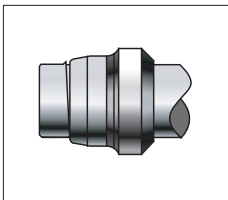

Remedy:
The sleeve may become cocked on the tube when the tube end is not properly lined up with the body. Generally, this condition is caused by faulty tube bending. All bent tube assemblies should drop into the fitting body prior to make up. This assembly should be scrapped.

5. No bite

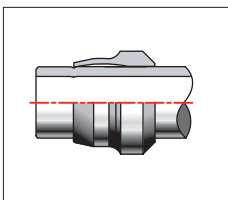

Remedy:
If all of the prior checks have been made and the sleeve still shows no sign of biting the tube, it may be that the tube is too hard. This assembly should be scrapped.

Ordering Information

Example 1

BCM - 08 - 02 R - B
 1 2 3 4 5

Example 2

BUS - 12 - 304
 1 2 3

1. Type of Fitting

Please refer to SUPERLOK JIS Tube Fitting Index on page 2.

2. Tube and Pipe

Metric	Out dia.	4	6	8	10	12.....	38	40	50
Tube	Designator	04	06	08	10	12.....	38	40	50
SCH, PIPE	Nominal dia.	1/8	1/4	3/8	1/2	3/4	1	1-1/4	1-1/2
	Out dia.	10.5	13.8	17.3	21.7	27.2	34.0	42.7	48.6
	Designator	6A	8A	10A	15A	20A	25A	32A	40A

3. Pipe Thread

Thread	1/8	1/4	3/8	1/2	3/4	1	1-1/4	1-1/2	2
Designator	01	02	03	04	06	08	10	12	16

4. Thread

Type	Designator	Specification
Taper Threads	R	JIS B 0203(PT), ISO 7/1
	N	ANSI B 1.20.1(NPT)
Parallel Threads	G	JIS B 0202(PF), ISO 228/1

5. Material

- **(Blank)** = 316 Stainless Steel
- **304** = 304 Stainless Steel
- **C** = Carbon Steel
- **B** = Brass

※ For special sizes and configurations, please consult BMT (SUPERLOK) sales representative.

BUS
Straight Union

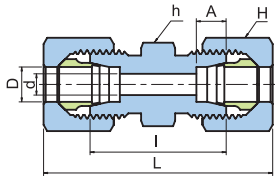
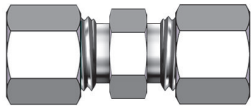

Part No.	Tube OD		Dimension					
	D		d	A	H	h	I	L
BUS-04	4		2.5	6	12	12	20	35
BUS-06	6		4	7	14	14	30	51
BUS-08	8		6	7	17	17	31	52
BUS-10	10		8	7	19	17	31	54
BUS-12	12		10	7	22	19	31	54
BUS-15	15		12	7.5	27	24	36	61
BUS-16	16		13	7.5	30	27	36	61
BUS-18	18		14	8	32	27	36	61
BUS-20	20		17	8	36	30	38	63
BUS-22	22		18	9	36	32	38	63
BUS-25	25		20	10	41	36	39	66
BUS-28	28		22	10	46	41	43	71
BUS-30	30		25	10	46	41	43	72
BUS-32	32		26	11	50	46	44	73
BUS-35	35		28	11	55	46	44	79
BUS-38	38		32	12	60	50	46	85
BUS-40	40		32	12	60	55	55	94
BUS-42	42		34	12	60	55	55	94
BUS-50	50		40	12	75	65	60	103
BUS-6A	1/8	10.5	8	7	19	17	31	54
BUS-8A	1/4	13.8	11	7.5	24	22	36	60
BUS-10A	3/8	17.3	14	8	32	27	36	61
BUS-15A	1/2	21.7	18	9	36	32	38	63
BUS-20A	3/4	27.2	22	10	46	41	43	71
BUS-25A	1	34.0	28	11	55	46	44	79
BUS-32A	1-1/4	42.7	34	12	65	60	57	98
BUS-40A	1-1/2	48.6	40	12	75	65	60	103

BUE
Union Elbow

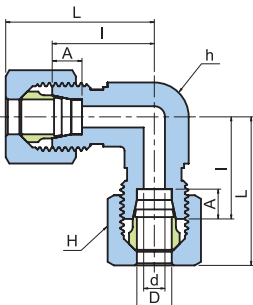
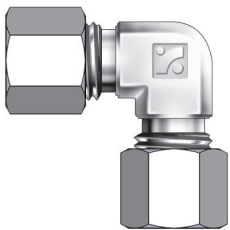

Part No.	Tube OD		Dimension					
	D		d	A	H	h	I	L
BUE-04	4		2.5	6	12	12	15	22.5
BUE-06	6		4	7	14	14	20	30.5
BUE-08	8		6	7	17	17	23	33.5
BUE-10	10		8	7	19	17	23	34.5
BUE-12	12		10	7	22	19	24	35.5
BUE-15	15		12	7.5	27	24	29	41.5
BUE-16	16		13	7.5	30	27	32	44.5
BUE-18	18		14	8	32	27	32	44.5
BUE-20	20		17	8	36	30	33	45.5
BUE-22	22		18	9	36	32	34	46.5
BUE-25	25		20	10	41	36	36	49.5
BUE-28	28		22	10	46	41	41	55
BUE-30	30		25	10	46	41	41	55.5
BUE-32	32		26	11	50	46	45	59.5
BUE-35	35		28	11	55	46	46	63.5
BUE-38	38		32	12	60	50	50	69.5
BUE-40	40		32	12	60	55	55	74.5
BUE-42	42		34	12	60	55	55	74.5
BUE-50	50		40	12	75	65	62	83.5
BUE-6A	1/8	10.5	8	7	19	17	23	34.5
BUE-8A	1/4	13.8	11	7.5	24	22	28	40
BUE-10A	3/8	17.3	14	8	32	27	32	44.5
BUE-15A	1/2	21.7	18	9	36	32	34	46.5
BUE-20A	3/4	27.2	22	10	46	41	41	55
BUE-25A	1	34.0	28	11	55	46	46	63.5
BUE-32A	1-1/4	42.7	34	12	65	60	57	77.5
BUE-40A	1-1/2	48.6	40	12	75	65	62	83.5

- Dimensions and Drawings are for reference only and are subject to change without prior notice.
- Unless otherwise specified, all dimensions are in millimeters.
- Sizes, pressure classes, and end connections not listed are available upon request.
- Length given approximate figure with tightened nut.

BUT
Union Tee

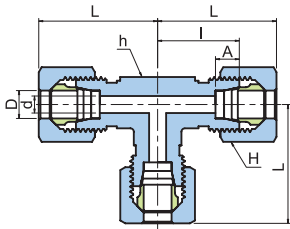
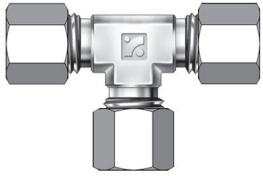

Part No.	Tube OD		Dimension					
	D		d	A	H	h	I	L
BUT-04	4		2.5	6	12	12	15	22.5
BUT-06	6		4	7	14	14	20	30.5
BUT-08	8		6	7	17	17	23	33.5
BUT-10	10		8	7	19	17	23	34.5
BUT-12	12		10	7	22	19	24	35.5
BUT-15	15		12	7.5	27	24	29	41.5
BUT-16	16		13	7.5	30	27	32	44.5
BUT-18	18		14	8	32	27	32	44.5
BUT-20	20		17	8	36	30	33	45.5
BUT-22	22		18	9	36	32	34	46.5
BUT-25	25		20	10	41	36	36	49.5
BUT-28	28		22	10	46	41	41	55
BUT-30	30		25	10	46	41	41	55.5
BUT-32	32		26	11	50	46	45	59.5
BUT-35	35		28	11	55	46	46	63.5
BUT-38	38		32	12	60	50	50	69.5
BUT-40	40		32	12	60	55	55	74.5
BUT-42	42		34	12	60	55	55	74.5
BUT-50	50		40	12	75	65	62	83.5
BUT-6A	1/8	10.5	8	7	19	17	23	34.5
BUT-8A	1/4	13.8	11	7.5	24	22	28	40
BUT-10A	3/8	17.3	14	8	32	27	32	44.5
BUT-15A	1/2	21.7	18	9	36	32	34	46.5
BUT-20A	3/4	27.2	22	10	46	41	41	55
BUT-25A	1	34.0	28	11	55	46	46	63.5
BUT-32A	1-1/4	42.7	34	12	65	60	57	77.5
BUT-40A	1-1/2	48.6	40	12	75	65	62	83.5

BUC
Union Cross

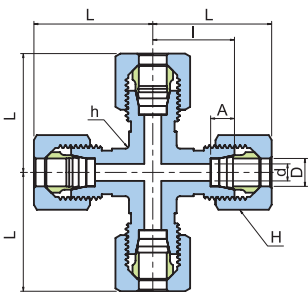
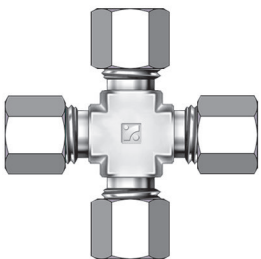

Part No.	Tube OD		Dimension					
	D		d	A	H	h	I	L
BUC-06	6		4	7	14	17	23	33.5
BUC-08	8		6	7	17	17	23	33.5
BUC-10	10		8	7	19	19	24	35.5
BUC-12	12		10	7	22	19	24	35.5
BUC-15	15		12	7.5	27	27	32	44.5
BUC-16	16		13	7.5	30	27	32	44.5
BUC-18	18		14	8	32	30	33	45.5
BUC-20	20		17	8	36	30	33	45.5
BUC-25	25		20	10	41	36	36	49.5
BUC-30	30		25	10	46	46	45	59.5
BUC-32	32		26	11	50	46	45	59.5

- Dimensions and Drawings are for reference only and are subject to change without prior notice.
- Unless otherwise specified, all dimensions are in millimeters.
- Sizes, pressure classes, and end connections not listed are available upon request.
- Length given approximate figure with tightened nut.

BBHU
Bulkhead Union

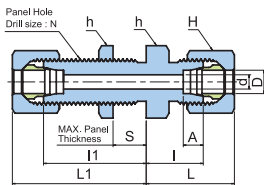
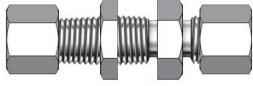

Part No.	Tube OD		Dimension									
	D		d	A	H	h	I	I1	L	L1	S	N
BBHU-04	4		2.5	6	12	14	14	25	21.5	32.5	13	10.5
BBHU-06	6		4	7	14	17	19	32	29.5	42.5	13	12.5
BBHU-08	8		6	7	17	19	19	32	29.5	42.5	13	14.5
BBHU-10	10		8	7	19	22	20	32	31.5	43.5	13	16.5
BBHU-12	12		10	7	22	24	20	32	31.5	43.5	13	18.5
BBHU-15	15		12	7.5	27	27	22	37	34.5	49.5	15	22.5
BBHU-16	16		13	7.5	30	30	24	37	36.5	49.5	15	24.5
BBHU-18	18		14	8	32	32	24	39	36.5	51.5	15	26.5
BBHU-20	20		17	8	36	32	24	39	36.5	51.5	15	28.5
BBHU-22	22		18	9	36	36	25	39	37.5	51.5	15	30.5
BBHU-25	25		20	10	41	41	25	39	38.5	52.5	15	35.5
BBHU-28	28		22	10	46	46	28	41	42	55	15	38.5
BBHU-30	30		25	10	46	46	28	41	42.5	55.5	15	40.5
BBHU-32	32		26	11	50	50	30	43	44.5	57.5	15	42.5
BBHU-35	35		28	11	55	50	30	43	47.5	60.5	15	45.5
BBHU-38	38		32	12	60	55	31	45	50.5	64.5	15	48.5
BBHU-40	40		32	12	60	60	37	50	56.5	69.5	15	52.5
BBHU-50	50		40	12	75	70	43	50	64.5	71.5	15	64.5
BBHU-6A	1/8	10.5	8	7	19	22	20	32	31.5	43.5	13	16.5
BBHU-8A	1/4	13.8	11	7.5	24	27	22	37	34	49	15	20.5
BBHU-10A	3/8	17.3	14	8	32	32	24	39	36.5	51.5	15	26.5
BBHU-15A	1/2	21.7	18	9	36	36	25	39	37.5	51.5	15	30.5
BBHU-20A	3/4	27.2	22	10	46	46	28	41	42	55	15	38.5
BBHU-25A	1	34.0	28	11	55	50	30	43	47.5	60.5	15	45.5
BBHU-32A	1-1/4	42.7	34	12	65	65	40	50	60.5	70.5	15	56.5
BBHU-40A	1-1/2	48.6	40	12	75	70	43	50	64.5	71.5	15	64.5

BBUE
Bulkhead
Union Elbow

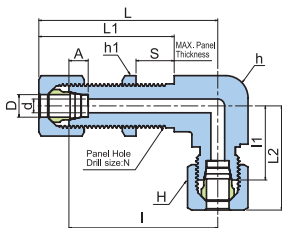
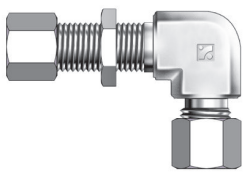

Part No.	Tube OD		Dimension											
	D		d	A	h1	H	A	I	I1	L	L1	L2	S	N
BBUE-06	6		4	17	17	14	7	45	23	55.5	42.5	33.5	13	12.5
BBUE-08	8		6	19	19	17	7	46	24	56.5	42.5	34.5	13	14.5
BBUE-10	10		8	22	22	19	7	48	26	59.5	43.5	37.5	13	16.5
BBUE-12	12		10	24	24	22	7	49	27	60.5	43.5	38.5	13	18.5
BBUE-15	15		12	27	27	27	7.5	57	31	69.5	49.5	43.5	15	22.5
BBUE-16	16		13	30	30	30	7.5	59	33	71.5	49.5	45.5	15	24.5
BBUE-18	18		14	32	32	32	8	63	33	75.5	51.5	45.5	15	26.5
BBUE-20	20		17	32	36	36	8	65	33	77.5	51.5	45.5	15	28.5
BBUE-22	22		18	36	36	36	9	65	36	77.5	51.5	48.5	15	30.5
BBUE-25	25		20	41	41	41	10	68	39	81.5	52.5	52.5	15	35.5
BBUE-28	28		22	41	46	46	10	70	41	84	55	55	15	38.5
BBUE-30	30		25	46	46	46	10	74	46	88.5	55.5	60.5	15	40.5

- Dimensions and Drawings are for reference only and are subject to change without prior notice.
- Unless otherwise specified, all dimensions are in millimeters.
- Sizes, pressure classes, and end connections not listed are available upon request.
- Length given approximate figure with tightened nut.

BCM-R
Male Connector

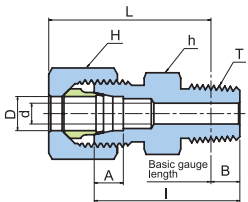
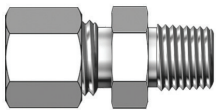

Part No.	Tube OD		Dimension							
	D		d	A	B	H	h	I	L	T
BCM-04-01R		4	2.5	6	3.97	12	12	22	25.5	PT 1/8
BCM-06-01R		6	4	7	3.97	14	14	28	34.5	PT 1/8
BCM-06-02R		6	4	7	6.01	14	17	33	37.5	PT 1/4
BCM-08-01R		8	4	7	3.97	17	17	29	35.5	PT 1/8
BCM-08-02R		8	6	7	6.01	17	17	33	37.5	PT 1/4
BCM-10-02R		10	7	7	6.01	19	17	33	38.5	PT 1/4
BCM-10-03R		10	8	7	6.35	19	19	34	39	PT 3/8
BCM-10-04R		10	8	7	8.16	19	22	39	42.5	PT 1/2
BCM-12-02R		12	7	7	6.01	22	19	33	38.5	PT 1/4
BCM-12-03R		12	9	7	6.35	22	19	34	39	PT 3/8
BCM-12-04R		12	10	7	8.16	22	24	39	42.5	PT 1/2
BCM-15-03R		15	9	7.5	6.35	27	24	37	43	PT 3/8
BCM-15-04R		15	12	7.5	8.16	27	24	41	45.5	PT 1/2
BCM-16-03R		16	9	7.5	6.35	30	27	37	43	PT 3/8
BCM-16-04R		16	12	7.5	8.16	30	27	41	45.5	PT 1/2
BCM-18-03R		18	9	8	6.35	32	27	37	43	PT 3/8
BCM-18-04R		18	12	8	8.16	32	27	41	45.5	PT 1/2
BCM-20-04R		20	12	8	8.16	36	30	43	47.5	PT 1/2
BCM-20-06R		20	16	8	9.53	36	30	45	48	PT 3/4
BCM-22-04R		22	12	9	8.16	36	32	43	47.5	PT 1/2
BCM-22-06R		22	16	9	9.53	36	32	45	48	PT 3/4
BCM-25-06R		25	16	10	9.53	41	36	46	50	PT 3/4
BCM-25-08R		25	20	10	10.39	41	36	49	52	PT 1
BCM-28-06R		28	16	10	9.53	46	41	48	52.5	PT 3/4
BCM-28-08R		28	22	10	10.39	46	41	51	54.5	PT 1
BCM-30-08R		30	22	10	10.39	46	41	51	55	PT 1
BCM-30-10R		30	25	10	12.70	46	46	55	57	PT 1-1/4
BCM-32-10R		32	26	11	12.70	50	46	55	57	PT 1-1/4
BCM-35-10R		35	28	11	12.70	55	46	55	60	PT 1-1/4
BCM-38-12R		38	32	12	12.70	60	50	57	64	PT 1-1/2
BCM-40-12R		40	32	12	12.70	60	55	62	69	PT 1-1/2
BCM-42-12R		42	34	12	12.70	60	55	62	69	PT 1-1/2
BCM-50-16R		50	40	12	15.88	75	65	71	76.5	PT 2
BCM-6A-01R	1/8	10.5	4	7	3.97	19	17	29	36.5	PT 1/8
BCM-6A-02R	1/8	10.5	7	7	6.01	19	17	33	38.5	PT 1/4
BCM-8A-02R	1/4	13.8	7	7.5	6.01	24	22	36	42	PT 1/4
BCM-8A-03R	1/4	13.8	9	7.5	6.35	24	22	37	42.5	PT 3/8
BCM-10A-03R	3/8	17.3	9	8	6.35	32	27	37	43	PT 3/8
BCM-10A-04R	3/8	17.3	12	8	8.16	32	27	41	45.5	PT 1/2
BCM-15A-04R	1/2	21.7	12	9	8.16	36	32	43	47.5	PT 1/2
BCM-15A-06R	1/2	21.7	16	9	9.53	36	32	45	48	PT 3/4
BCM-20A-06R	3/4	27.2	16	10	9.53	46	41	48	52.5	PT 3/4
BCM-20A-08R	3/4	27.2	22	10	10.39	46	41	51	54.5	PT 1
BCM-25A-08R	1	34.0	22	11	10.39	55	46	52	59	PT 1
BCM-25A-10R	1	34.0	28	11	12.70	55	46	55	60	PT 1-1/4
BCM-32A-10R	1-1/4	42.7	31	12	12.70	65	60	64	72	PT 1-1/4
BCM-32A-12R	1-1/4	42.7	34	12	12.70	65	60	64	72	PT 1-1/2
BCM-40A-12R	1-1/2	48.6	36	12	12.70	75	65	67	76	PT 1-1/2
BCM-40A-16R	1-1/2	48.6	40	12	15.88	75	65	71	76.5	PT 2

- Dimensions and Drawings are for reference only and are subject to change without prior notice.
 - Unless otherwise specified, all dimensions are in millimeters.
 - Sizes, pressure classes, and end connections not listed are available upon request.
 - Length given approximate figure with tightened nut.

BCM-G

Male Connector
(For Copper
Gasket)

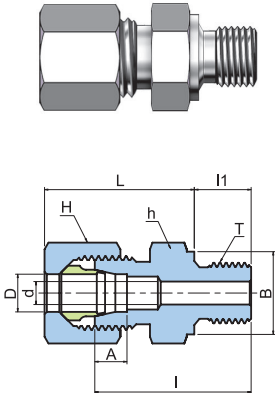

Part No.	Tube OD		Dimension								
	D		d	A	B	H	h	I	I1	L	T
BCM-04-01G	4		2.5	6	14	12	14	23	8	22.5	PF1/8
BCM-06-01G	6		4	7	14	14	14	28	8	30.5	PF1/8
BCM-06-02G	6		4	7	18	14	19	33	12	31.5	PF1/4
BCM-08-01G	8		4	7	14	17	17	28	8	30.5	PF1/8
BCM-08-02G	8		6	7	18	17	19	33	12	31.5	PF1/4
BCM-10-02G	10		6	7	18	19	19	33	12	32.5	PF1/4
BCM-10-03G	10		8	7	21.5	19	22	34	12	33.5	PF3/8
BCM-12-02G	12		6	7	18	22	19	33	12	32.5	PF1/4
BCM-12-03G	12		8	7	21.5	22	22	34	12	33.5	PF3/8
BCM-12-04G	12		10	7	25.5	22	27	39	14	36.5	PF1/2
BCM-15-03G	15		8	7.5	21.5	27	24	37	12	37.5	PF3/8
BCM-15-04G	15		12	7.5	25.5	27	27	41	14	39.5	PF1/2
BCM-16-04G	16		12	7.5	25.5	30	27	41	14	39.5	PF1/2
BCM-18-04G	18		12	8	25.5	32	27	41	14	39.5	PF1/2
BCM-20-06G	20		16	8	31.5	36	32	46	16	42.5	PF3/4
BCM-22-04G	22		12	9	25.5	36	32	43	14	41.5	PF1/2
BCM-22-06G	22		16	9	31.5	36	32	46	16	42.5	PF3/4
BCM-25-06G	25		16	10	31.5	41	36	46	16	43.5	PF3/4
BCM-25-08G	25		20	10	38	41	41	50	18	45.5	PF1
BCM-28-08G	28		22	10	38	46	41	52	18	48	PF1
BCM-30-08G	30		22	10	38	46	41	52	18	48.5	PF1
BCM-30-10G	30		25	10	48.5	46	50	57	20	51.5	PF1-1/4
BCM-32-10G	32		26	11	48.5	50	50	57	20	51.5	PF1-1/4
BCM-35-10G	35		28	11	48.5	55	50	57	20	54.5	PF1-1/4
BCM-38-12G	38		32	12	53.5	60	55	58	21	56.5	PF1-1/2
BCM-40-12G	40		32	12	53.5	60	55	62	21	60.5	PF1-1/2
BCM-42-12G	42		34	12	53.5	60	55	62	21	60.5	PF1-1/2
BCM-50-16G	50		40	12	66	75	70	73	25	69.5	PF2
BCM-6A-01G	1/8	10.5	4	7	14	19	17	29	8	32.5	PF1/8
BCM-6A-02G	1/8	10.5	6	7	18	19	19	33	12	32.5	PF1/4
BCM-8A-02G	1/4	13.8	6	7.5	18	24	22	36	12	36	PF1/4
BCM-8A-03G	1/4	13.8	8	7.5	21.5	24	22	36	12	36	PF3/8
BCM-10A-03G	3/8	17.3	8	8	21.5	32	27	38	12	38.5	PF3/8
BCM-10A-04G	3/8	17.3	12	8	25.5	32	27	41	14	39.5	PF1/2
BCM-15A-04G	1/2	21.7	12	9	25.5	36	32	43	14	41.5	PF1/2
BCM-15A-06G	1/2	21.7	16	9	31.5	36	32	46	16	42.5	PF3/4
BCM-20A-06G	3/4	27.2	16	10	31.5	46	41	50	16	48	PF3/4
BCM-20A-08G	3/4	27.2	22	10	38	46	41	52	18	48	PF1
BCM-25A-08G	1	34.0	22	11	38	55	46	54	18	53.5	PF1
BCM-25A-10G	1	34.0	28	11	48.5	55	50	57	20	54.5	PF1-1/4
BCM-32A-10G	1-1/4	42.7	31	12	48.5	65	60	63	20	63.5	PF1-1/4
BCM-32A-12G	1-1/4	42.7	34	12	53.5	65	60	64	21	63.5	PF1-1/2
BCM-40A-12G	1-1/2	48.6	36	12	53.5	75	65	65	21	65.5	PF1-1/2
BCM-40A-16G	1-1/2	48.6	40	12	66	75	70	73	25	69.5	PF2

- Dimensions and Drawings are for reference only and are subject to change without prior notice.
- Unless otherwise specified, all dimensions are in millimeters.
- Sizes, pressure classes, and end connections not listed are available upon request.
- Length given approximate figure with tightened nut.

BCM-GO

Male Connector
(For O-Ring)

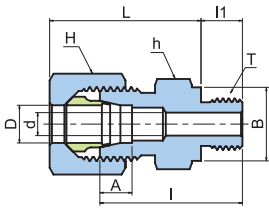
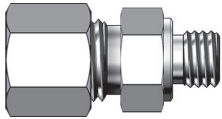

Part No.	Tube OD		Dimension								
	D		d	A	B	H	h	l	l1	L	T
BCM-04-01GO	4		2.5	6	14	12	14	23	8	22.5	PF 1/8
BCM-06-01GO	6		4	7	14	14	14	28	8	30.5	PF 1/8
BCM-06-02GO	6		4	7	19	14	19	33	12	31.5	PF 1/4
BCM-08-01GO	8		4	7	14	17	17	28	8	30.5	PF 1/8
BCM-08-02GO	8		6	7	19	17	19	33	12	31.5	PF 1/4
BCM-10-02GO	10		6	7	19	19	19	33	12	32.5	PF 1/4
BCM-10-03GO	10		8	7	22	19	22	34	12	33.5	PF 3/8
BCM-12-02GO	12		6	7	19	22	19	33	12	32.5	PF 1/4
BCM-12-03GO	12		8	7	22	22	22	34	12	33.5	PF 3/8
BCM-12-04GO	12		10	7	27	22	27	39	14	36.5	PF 1/2
BCM-15-03GO	15		8	7.5	22	27	24	37	12	37.5	PF 3/8
BCM-15-04GO	15		12	7.5	27	27	27	41	14	39.5	PF 1/2
BCM-16-04GO	16		12	7.5	27	30	27	41	14	39.5	PF 1/2
BCM-18-04GO	18		12	8	27	32	27	41	14	39.5	PF 1/2
BCM-20-06GO	20		16	8	36	36	36	46	16	42.5	PF 3/4
BCM-22-04GO	22		12	9	27	36	32	43	14	41.5	PF 1/2
BCM-22-06GO	22		16	9	36	36	36	46	16	42.5	PF 3/4
BCM-25-06GO	25		16	10	36	41	36	46	16	43.5	PF 3/4
BCM-25-08GO	25		20	10	41	41	41	50	18	45.5	PF 1
BCM-28-08GO	28		22	10	41	46	41	52	18	48	PF 1
BCM-30-08GO	30		22	10	41	46	41	52	18	48.5	PF 1
BCM-30-10GO	30		25	10	50	46	50	57	20	51.5	PF 1-1/4
BCM-32-10GO	32		26	11	50	50	50	57	20	51.5	PF 1-1/4
BCM-35-10GO	35		28	11	50	55	50	57	20	54.5	PF 1-1/4
BCM-38-12GO	38		32	12	55	60	55	58	21	56.5	PF 1-1/2
BCM-40-12GO	40		32	12	55	60	55	62	21	60.5	PF 1-1/2
BCM-42-12GO	42		34	12	55	60	55	62	21	60.5	PF 1-1/2
BCM-50-16GO	50		40	12	75	75	70	73	25	69.5	PF 2
BCM-6A-01GO	1/8	10.5	4	7	14	19	17	29	8	32.5	PF 1/8
BCM-6A-02GO	1/8	10.5	6	7	19	19	19	33	12	32.5	PF 1/4
BCM-8A-02GO	1/4	13.8	6	7.5	19	24	22	36	12	36	PF 1/4
BCM-8A-03GO	1/4	13.8	8	7.5	22	24	22	36	12	36	PF 3/8
BCM-10A-03GO	3/8	17.3	8	8	22	32	27	38	12	38.5	PF 3/8
BCM-10A-04GO	3/8	17.3	12	8	27	32	27	41	14	39.5	PF 1/2
BCM-15A-04GO	1/2	21.7	12	9	27	36	32	43	14	41.5	PF 1/2
BCM-15A-06GO	1/2	21.7	16	9	36	36	36	46	16	42.5	PF 3/4
BCM-20A-06GO	3/4	27.2	16	10	36	46	41	50	16	48	PF 3/4
BCM-20A-08GO	3/4	27.2	22	10	41	46	41	52	18	48	PF 1
BCM-25A-08GO	1	34.0	22	11	41	55	46	54	18	53.5	PF 1
BCM-25A-10GO	1	34.0	28	11	50	55	50	57	20	54.5	PF 1-1/4
BCM-32A-10GO	1-1/4	42.7	31	12	50	65	60	63	20	63.5	PF 1-1/4
BCM-32A-12GO	1-1/4	42.7	34	12	55	65	60	64	21	63.5	PF 1-1/2
BCM-40A-12GO	1-1/2	48.6	36	12	55	75	65	65	21	65.5	PF 1-1/2
BCM-40A-16GO	1-1/2	48.6	40	12	75	75	75	73	25	69.5	PF 2

- Dimensions and Drawings are for reference only and are subject to change without prior notice.
- Unless otherwise specified, all dimensions are in millimeters.
- Sizes, pressure classes, and end connections not listed are available upon request.
- Length given approximate figure with tightened nut.

BLCM

Long
Male Connector

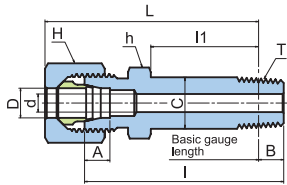
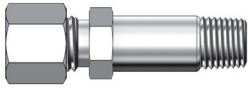

Part No.	Tube OD D	Dimension										
		d	A	B	C	H	h	I	I1	L	T	
BLCM-04-01R	4	2.5	6	3.97	10.5	12	12	46	30	49.5	PT 1/8	
BLCM-06-01R	6	4	7	3.97	10.5	14	14	63	41	69.5	PT 1/8	
BLCM-08-02R	8	6	7	6.01	14	17	17	70	45	74.5	PT 1/4	
BLCM-10-02R	10	7	7	6.01	14	19	17	71	46	76.5	PT 1/4	
BLCM-10-03R	10	8	7	6.35	17.5	19	19	72	46.5	77	PT 3/8	
BLCM-12-02R	12	7	7	6.01	14	22	19	71	46	76.5	PT 1/4	
BLCM-12-03R	12	9	7	6.35	17.5	22	19	72	46.5	77	PT 3/8	
BLCM-15-03R	15	9	7.5	6.35	17.5	27	24	81	52.5	87	PT 3/8	
BLCM-15-04R	15	12	7.5	8.16	22	27	24	86	56	90.5	PT 1/2	
BLCM-16-04R	16	12	7.5	8.16	22	30	27	86	56	90.5	PT 1/2	
BLCM-18-04R	18	12	8	8.16	22	32	27	86	56	90.5	PT 1/2	
BLCM-20-06R	20	16	8	9.53	27.5	36	30	92	58.5	95	PT 3/4	
BLCM-22-06R	22	16	9	9.53	27.5	36	32	93	59.5	96	PT 3/4	
BLCM-25-08R	25	20	10	10.39	34	41	36	99	63.5	102	PT 1	
BLCM-28-08R	28	22	10	10.39	34	46	41	104	66.5	107.5	PT 1	
BLCM-30-10R	30	25	10	12.70	42.5	46	46	109	68.5	111	PT 1-1/4	
BLCM-32-10R	32	26	11	12.70	42.5	50	46	110	69.5	112	PT 1-1/4	
BLCM-6A-02R	1/8 10.5	7	7	6.01	14	19	17	71	46	76.5	PT 1/4	
BLCM-8A-03R	1/4 13.8	9	7.5	6.35	17.5	24	22	81	52.5	86.5	PT 3/8	
BLCM-10A-03R	3/8 17.3	9	8	6.35	17.5	32	27	81	52.5	87	PT 3/8	
BLCM-15A-04R	3/8 17.3	12	8	8.16	22	32	27	86	56	90.5	PT 1/2	
BLCM-20A-06R	1/2 21.7	16	9	9.53	27.5	36	32	93	59.5	96	PT 3/4	
BLCM-25A-08R	3/4 27.2	22	10	10.39	34	46	41	104	66.5	107.5	PT 1	

- Dimensions and Drawings are for reference only and are subject to change without prior notice.
- Unless otherwise specified, all dimensions are in millimeters.
- Sizes, pressure classes, and end connections not listed are available upon request.
- Length given approximate figure with tightened nut.

BME
Male Elbow

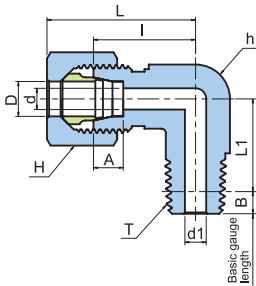
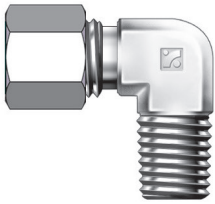

Part No.	Tube OD		Dimension									
	D		d	d1	A	B	H	h	I	L	L1	T
BME-04-01R	4		2.5	4	6	3.97	12	12	17	22.5	14.7	PT 1/8
BME-06-01R	6		4	4	7	3.97	14	14	20	30.5	14	PT 1/8
BME-06-02R	6		4	7	7	6.01	14	17	23	33.5	17	PT 1/4
BME-08-01R	8		6	4	7	3.97	17	17	23	33.5	16	PT 1/8
BME-08-02R	8		6	7	7	6.01	17	17	23	33.5	18	PT 1/4
BME-10-02R	10		8	7	7	6.01	19	17	23	34.5	19	PT 1/4
BME-10-03R	10		8	9	7	6.35	19	19	24	35.5	19.5	PT 3/8
BME-10-04R	10		8	12	7	8.16	19	22	29	40.5	26	PT 1/2
BME-12-02R	12		10	7	7	6.01	22	19	24	35.5	20	PT 1/4
BME-12-03R	12		10	9	7	6.35	22	19	24	35.5	20.5	PT 3/8
BME-12-04R	12		10	12	7	8.16	22	24	29	40.5	26	PT 1/2
BME-15-03R	15		12	9	7.5	6.35	27	24	29	41.5	23.5	PT 3/8
BME-15-04R	15		12	12	7.5	8.16	27	24	29	41.5	26	PT 1/2
BME-16-03R	16		13	9	7.5	6.35	30	27	32	44.5	25.5	PT 3/8
BME-16-04R	16		13	12	7.5	8.16	30	27	32	44.5	27	PT 1/2
BME-18-03R	18		14	9	8	6.35	32	27	32	44.5	27.5	PT 3/8
BME-18-04R	18		14	12	8	8.16	32	27	32	44.5	30	PT 1/2
BME-20-04R	20		17	12	8	8.16	36	30	33	45.5	32	PT 1/2
BME-20-06R	20		17	16	8	9.53	36	30	33	45.5	30.5	PT 3/4
BME-22-04R	22		18	12	9	8.16	36	32	34	46.5	32	PT 1/2
BME-22-06R	22		18	16	9	9.53	36	32	34	46.5	32.5	PT 3/4
BME-25-06R	25		20	16	10	9.53	41	36	36	49.5	33.5	PT 3/4
BME-25-08R	25		20	22	10	10.39	41	36	36	49.5	35.5	PT 1
BME-28-06R	28		22	16	10	9.53	46	41	41	55	37.5	PT 3/4
BME-28-08R	28		22	22	10	10.39	46	41	41	55	39.5	PT 1
BME-30-08R	30		25	22	10	10.39	46	41	41	55.5	39.5	PT 1
BME-30-10R	30		25	31	10	12.70	46	46	46	60.5	42.5	PT 1-1/4
BME-32-10R	32		26	31	11	12.70	50	46	46	60.5	43.5	PT 1-1/4
BME-35-10R	35		28	31	11	12.70	55	46	46	63.5	45.5	PT 1-1/4
BME-38-12R	38		32	36	12	12.70	60	50	50	69.5	48.5	PT 1-1/2
BME-40-12R	40		32	36	12	12.70	60	55	55	74.5	49.5	PT 1-1/2
BME-42-12R	42		34	36	12	12.70	60	55	55	74.5	49.5	PT 1-1/2
BME-50-16R	50		40	46	12	15.88	75	65	62	83.5	58	PT 2
BME-6A-01R	1/8	10.5	8	4	7	3.97	19	17	23	34.5	17	PT 1/8
BME-6A-02R	1/8	10.5	8	7	7	6.01	19	17	23	34.5	19	PT 1/4
BME-8A-02R	1/4	13.8	11	7	7.5	6.01	24	22	28	40	22	PT 1/4
BME-8A-03R	1/4	13.8	11	9	7.5	6.35	24	22	28	40	22.5	PT 3/8
BME-10A-03R	3/8	17.3	14	9	8	6.35	32	27	32	44.5	27.5	PT 3/8
BME-10A-04R	3/8	17.3	14	12	8	8.16	32	27	32	44.5	30	PT 1/2
BME-15A-04R	1/2	21.7	18	12	9	8.16	36	32	34	46.5	32	PT 1/2
BME-15A-06R	1/2	21.7	18	16	9	9.53	36	32	34	46.5	32.5	PT 3/4
BME-20A-06R	3/4	27.2	22	16	10	9.53	46	41	41	55	37.5	PT 3/4
BME-20A-08R	3/4	27.2	22	22	10	10.39	46	41	41	55	39.5	PT 1
BME-25A-08R	1	34.0	28	22	11	10.39	55	46	46	63.5	44.5	PT 1
BME-25A-10R	1	34.0	28	31	11	12.70	55	46	46	63.5	45.5	PT 1-1/4
BME-32A-10R	1-1/4	42.7	34	31	12	12.70	65	60	57	77.5	51.5	PT 1-1/4
BME-32A-12R	1-1/4	42.7	34	36	12	12.70	75	60	57	77.5	51.5	PT 1-1/2
BME-40A-12R	1-1/2	48.6	40	36	12	12.70	75	65	62	83.5	57.5	PT 1-1/2
BME-40A-16R	1-1/2	48.6	40	46	12	15.88	75	65	62	83.5	58	PT 2

- Dimensions and Drawings are for reference only and are subject to change without prior notice.
 - Unless otherwise specified, all dimensions are in millimeters.
 - Sizes, pressure classes, and end connections not listed are available upon request.
 - Length given approximate figure with tightened nut.

BLME

Long
Male Elbow

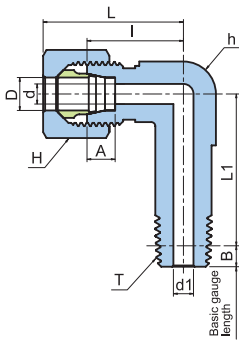
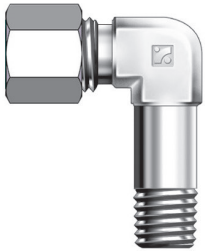

Part No.	Tube OD D	Dimension									
		d	d1	A	B	H	h	I	L	L1	T
BLME-06-01R	6	4	4	7	3.97	14	14	20	30.5	36	PT 1/8
BLME-08-02R	8	6	7	7	6.01	17	17	23	33.5	43	PT 1/4
BLME-10-02R	10	8	7	7	6.01	19	17	23	34.5	46	PT 1/4
BLME-12-02R	12	10	7	7	6.01	22	19	24	35.5	52	PT 1/4
BLME-12-03R	12	10	9	7	6.35	22	19	24	35.5	53	PT 3/8
BLME-15-03R	15	12	9	7.5	6.35	27	24	29	41.5	61.5	PT 3/8
BLME-15-04R	15	12	12	7.5	8.16	27	24	29	41.5	67	PT 1/2
BLME-16-04R	16	13	12	7.5	8.16	30	27	32	44.5	70	PT 1/2
BLME-18-04R	18	14	12	8	8.16	32	27	32	44.5	77	PT 1/2
BLME-20-06R	20	17	16	8	9.53	36	30	33	45.5	82.5	PT 3/4
BLME-22-06R	22	18	16	9	9.53	36	32	34	46.5	83.5	PT 3/4
BLME-25-06R	25	20	16	10	9.53	41	36	36	49.5	90.5	PT 3/4
BLME-25-08R	25	20	22	10	10.39	41	36	36	49.9	91.5	PT 1
BLME-28-08R	28	22	22	10	10.39	46	41	41	55	104.5	PT 1
BLME-30-10R	30	25	31	10	12.70	46	46	46	60.5	104.5	PT 1-1/4
BLME-32-10R	32	26	31	11	12.70	50	46	46	60.5	104.5	PT 1-1/4
BLME-35-10R	35	28	31	11	12.70	55	46	46	63.5	121.5	PT 1-1/4

BPME

Positionable
Male Elbow

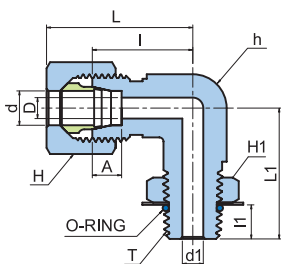
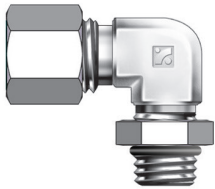

Part No.	Tube OD D	Dimension										
		d	d1	A	H	H1	h	I	I1	L	L1	T
BPME-06-01G	6	4	4	7	14	14	14	20	10	30.5	30	PF 1/8
BPME-08-02G	8	6	6	7	17	19	17	23	12	33.5	34	PF 1/4
BPME-10-02G	10	8	6	7	19	19	17	23	12	34.5	35	PF 1/4
BPME-12-02G	12	10	6	7	22	19	19	24	12	35.5	36	PF 1/4
BPME-12-03G	12	10	9	7	22	22	19	24	12	35.5	36	PF 3/8
BPME-12-04G	12	10	12	7	22	27	24	24	16	35.5	46	PF 1/2
BPME-15-03G	15	12	9	7.5	27	22	24	29	12	41.5	40	PF 3/8
BPME-15-04G	15	12	12	7.5	27	27	24	29	16	41.5	46	PF 1/2
BPME-16-04G	16	13	12	7.5	30	27	24	32	16	44.5	46	PF 1/2
BPME-18-04G	18	14	12	8	32	27	30	32	16	44.5	52	PF 1/2
BPME-20-06G	20	17	16	8	36	36	30	33	17	45.5	52	PF 3/4
BPME-22-06G	22	18	16	9	36	36	32	34	17	46.5	52	PF 3/4
BPME-25-06G	25	20	16	10	41	36	36	36	17	49.5	60	PF 3/4
BPME-25-08G	25	20	22	10	41	41	36	36	21	49.5	62	PF 1
BPME-28-08G	28	22	22	10	46	41	41	41	21	55	62	PF 1
BPME-30-08G	30	25	22	10	46	41	41	41	21	55.5	66	PF 1
BPME-30-10G	30	25	31	10	46	50	46	44	21	58.5	66	PF 1-1/4
BPME-32-10G	32	26	31	11	50	50	46	46	21	60.5	66	PF 1-1/4
BPME-35-10G	35	28	31	11	55	50	46	46	21	63.5	66	PF 1-1/4
BPME-38-12G	38	32	36	12	60	55	50	50	21	69.5	73	PF 1-1/2

- Dimensions and Drawings are for reference only and are subject to change without prior notice.
- Unless otherwise specified, all dimensions are in millimeters.
- Sizes, pressure classes, and end connections not listed are available upon request.
- Length given approximate figure with tightened nut.

BBE
Banjo Elbow

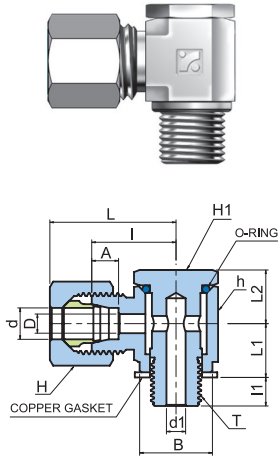

Part No.	Tube OD D	Dimension													
		d	d1	A	B	H	H1	h	I	I1	L	L1	L2	O-Ring	T
BBE-06-01G	6	4	4	7	14	14	17	17	23	8	33.5	13	14	P10	PF1/8
BBE-08-02G	8	6	7	7	18	17	22	22	25	12	35.5	16	17	P12	PF1/4
BBE-10-02G	10	8	7	7	18	19	22	22	25	12	36.5	16	17	P12	PF1/4
BBE-12-03G	12	10	9	7	21.5	22	27	27	29	12	40.5	19	22	P18	PF3/8
BBE-15-04G	15	12	12	7.5	25.5	27	30	36	36	14	48.5	24	28	P22	PF1/2
BBE-16-04G	16	13	12	7.5	25.5	30	30	36	36	14	48.5	24	28	P22	PF1/2
BBE-18-04G	18	14	12	8	25.5	32	30	36	36	14	48.5	24	28	P22	PF1/2
BBE-20-06G	20	17	16	8	31.5	36	41	41	38	16	50.5	28	32	P28	PF3/4
BBE-22-06G	22	18	16	9	31.5	36	41	42	38	16	50.5	28	32	P28	PF3/4
BBE-25-08G	25	20	22	10	38	41	50	50	42	18	55.5	37	38	P36	PF1
BBE-28-08G	28	22	22	10	38	46	50	50	42	18	56	37	38	P36	PF1
BBE-6A-02G	1/8 10.5	8	7	7	18	19	22	22	25	12	36.5	16	17	P12	PF1/4
BBE-8A-03G	1/4 13.8	11	9	7.5	21.5	24	27	27	29	12	41	19	22	P18	PF3/8
BBE-10A-04G	3/8 17.3	14	12	8	25.5	32	30	36	36	14	48.5	24	28	P22	PF1/2
BBE-15A-06G	1/2 21.7	18	16	9	31.5	36	41	41	38	16	50.5	28	32	P28	PF3/4
BBE-20A-08G	3/4 27.2	22	22	10	38	46	50	50	42	18	56	37	38	P36	PF1

BMBT
Male Branch Tee

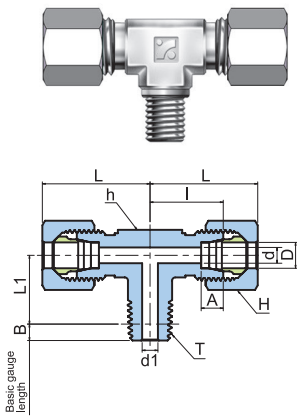

Part No.	Tube OD D	Dimension									
		d	d1	A	B	H	h	I	L	L1	T
BMBT-04-01R	4	2.5	4	6	3.97	12	12	15	22.5	13	PT 1/8
BMBT-06-01R	6	4	4	7	3.97	14	14	20	30.5	14	PT 1/8
BMBT-06-02R	6	4	7	7	6.01	14	17	23	33.5	17	PT 1/4
BMBT-08-01R	8	6	4	7	3.97	17	17	23	33.5	16	PT 1/8
BMBT-08-02R	8	6	7	7	6.01	17	17	23	33.5	18	PT 1/4
BMBT-10-02R	10	8	7	7	6.01	19	17	23	34.5	19	PT 1/4
BMBT-10-03R	10	8	9	7	6.35	19	19	24	35.5	19.5	PT 3/8
BMBT-12-02R	12	10	7	7	6.01	22	19	24	35.5	18	PT 1/4
BMBT-12-03R	12	10	9	7	6.35	22	19	24	35.5	20.5	PT 3/8
BMBT-15-03R	15	12	9	7.5	6.35	27	24	29	41.5	23.5	PT 3/8
BMBT-15-04R	15	12	12	7.5	8.16	27	24	29	41.5	26	PT 1/2
BMBT-16-04R	16	13	12	7.5	8.16	30	27	32	44.5	27	PT 1/2
BMBT-18-04R	18	14	12	8	8.16	32	27	32	44.5	30	PT 1/2
BMBT-20-06R	20	17	16	8	9.53	36	30	33	45.5	30.5	PT 3/4
BMBT-22-06R	22	18	16	9	9.53	36	32	34	46.5	32.5	PT 3/4
BMBT-25-06R	25	20	16	10	9.53	41	36	36	49.5	33.5	PT 3/4
BMBT-25-08R	25	20	22	10	10.39	41	36	36	49.5	35.5	PT 1
BMBT-28-08R	28	22	22	10	10.39	46	41	41	55	39.5	PT 1
BMBT-30-08R	30	25	22	10	10.39	46	41	41	55.5	39.5	PT 1
BMBT-30-10R	30	25	31	10	12.70	46	46	46	60.5	42.5	PT 1-1/4
BMBT-32-10R	32	26	31	11	12.70	50	46	46	60.5	43.5	PT 1-1/4
BMBT-35-10R	35	28	31	11	12.70	55	46	46	63.5	45.5	PT 1-1/4
BMBT-38-12R	38	32	36	12	12.70	60	50	50	69.5	48.5	PT 1-1/2
BMBT-40-12R	40	32	36	12	12.70	60	55	55	74.5	49.5	PT 1-1/2
BMBT-50-16R	50	40	46	12	15.88	75	65	62	83.5	58	PT 2
BMBT-6A-02R	1/8 10.5	8	7	7	6.01	19	17	23	34.5	19	PT 1/4
BMBT-8A-03R	1/4 13.8	11	9	7.5	6.35	24	22	28	40	22.5	PT 3/8
BMBT-10A-04R	3/8 17.3	14	12	8	8.16	32	27	32	44.5	30	PT 1/2
BMBT-15A-06R	1/2 21.7	18	16	9	9.53	36	32	34	46.5	32.5	PT 3/4
BMBT-20A-08R	3/4 27.2	22	22	10	10.39	46	41	41	55	39.5	PT 1
BMBT-25A-10R	1 34.0	28	31	11	12.70	55	46	46	63.5	45.5	PT 1-1/4
BMBT-32A-12R	1-1/4 42.7	34	36	12	12.70	65	60	57	77.5	51.5	PT 1-1/2
BMBT-40A-16R	1-1/2 48.6	40	46	12	15.88	75	65	62	83.5	58	PT 2

- Dimensions and Drawings are for reference only and are subject to change without prior notice.
 - Unless otherwise specified, all dimensions are in millimeters.
 - Sizes, pressure classes, and end connections not listed are available upon request.
 - Length given approximate figure with tightened nut.

BMRT

Male Run Tee

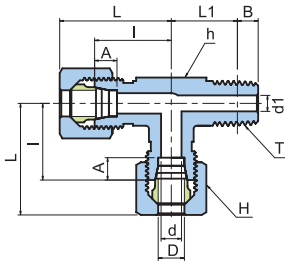
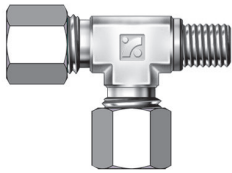

Part No.	Tube OD		Dimension									
	D		d	d1	A	B	H	h	l	L	L1	T
BMRT-04-01R	4		2.5	4	6	3.97	12	12	15	22.5	13	PT 1/8
BMRT-06-01R	6		4	4	7	3.97	14	14	20	30.5	14	PT 1/8
BMRT-06-02R	6		4	7	7	6.01	14	17	23	33.5	17	PT 1/4
BMRT-08-01R	8		6	4	7	3.97	17	17	23	33.5	16	PT 1/8
BMRT-08-02R	8		6	7	7	6.01	17	17	23	33.5	18	PT 1/4
BMRT-10-02R	10		8	7	7	6.01	19	17	23	34.5	19	PT 1/4
BMRT-10-03R	10		8	9	7	6.35	19	19	24	35.5	19.5	PT 3/8
BMRT-12-02R	12		10	7	7	6.01	22	19	24	35.5	18	PT 1/4
BMRT-12-03R	12		10	9	7	6.35	22	19	24	35.5	20.5	PT 3/8
BMRT-15-03R	15		12	9	7.5	6.35	27	24	29	41.5	23.5	PT 3/8
BMRT-15-04R	15		12	12	7.5	8.16	27	24	29	41.5	26	PT 1/2
BMRT-16-04R	16		13	12	7.5	8.16	30	27	32	44.5	27	PT 1/2
BMRT-18-04R	18		14	12	8	8.16	32	27	32	44.5	30	PT 1/2
BMRT-20-06R	20		17	16	8	9.53	36	30	33	45.5	30.5	PT 3/4
BMRT-22-06R	22		18	16	9	9.53	36	32	34	46.5	32.5	PT 3/4
BMRT-25-06R	25		20	16	10	9.53	41	36	36	49.5	33.5	PT 3/4
BMRT-25-08R	25		20	22	10	10.39	41	36	36	49.5	35.5	PT 1
BMRT-28-08R	28		22	22	10	10.39	46	41	41	55	39.5	PT 1
BMRT-30-08R	30		25	22	10	10.39	46	41	41	55.5	39.5	PT 1
BMRT-30-10R	30		25	31	10	12.70	46	46	46	60.5	42.5	PT 1-1/4
BMRT-32-10R	32		26	31	11	12.70	50	46	46	60.5	43.5	PT 1-1/4
BMRT-35-10R	35		28	31	11	12.70	55	46	46	63.5	45.5	PT 1-1/4
BMRT-38-12R	38		32	36	12	12.70	60	50	50	69.5	48.5	PT 1-1/2
BMRT-40-12R	40		32	36	12	12.70	60	55	55	74.5	49.5	PT 1-1/2
BMRT-50-16R	50		40	46	12	15.88	75	65	62	83.5	58	PT 2
BMRT-6A-02R	1/8	10.5	8	7	7	6.01	19	17	23	34.5	19	PT 1/4
BMRT-8A-03R	1/4	13.8	11	9	7.5	6.35	24	22	28	40	22.5	PT 3/8
BMRT-10A-04R	3/8	17.3	14	12	8	8.16	32	27	32	44.5	30	PT 1/2
BMRT-15A-06R	1/2	21.7	18	16	9	9.53	36	32	34	46.5	32.5	PT 3/4
BMRT-20A-08R	3/4	27.2	22	22	10	10.39	46	41	41	55	39.5	PT 1
BMRT-25A-10R	1	34.0	28	31	11	12.70	55	46	46	63.5	45.5	PT 1-1/4
BMRT-32A-12R	1-1/4	42.7	34	36	12	12.70	65	60	57	77.5	51.5	PT 1-1/2
BMRT-40A-16R	1-1/2	48.6	40	46	12	15.88	75	65	62	83.5	58	PT 2

- Dimensions and Drawings are for reference only and are subject to change without prior notice.
- Unless otherwise specified, all dimensions are in millimeters.
- Sizes, pressure classes, and end connections not listed are available upon request.
- Length given approximate figure with tightened nut.

BCF

Female Connector

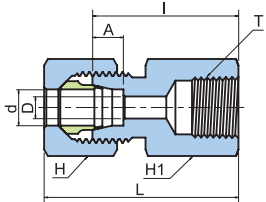
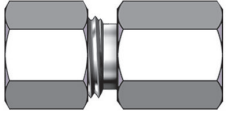

Part No.	Tube OD		Dimension						
	D	d	A	H	H1	I	L	T	
BCF-06-01R	6	4	7	14	17	25	35.5	PT 1/8	
BCF-08-02R	8	6	7	17	19	30	40.5	PT 1/4	
BCF-10-02R	10	8	7	19	19	30	41.5	PT 1/4	
BCF-10-03R	10	8	7	19	24	32	43.5	PT 3/8	
BCF-12-02R	12	10	7	22	19	30	41.5	PT 1/4	
BCF-12-03R	12	10	7	22	24	32	43.5	PT 3/8	
BCF-15-03R	15	12	7.5	27	24	34	46.5	PT 3/8	
BCF-15-04R	15	12	7.5	27	30	39	51.5	PT 1/2	
BCF-16-04R	16	13	7.5	30	30	39	51.5	PT 1/2	
BCF-18-04R	18	14	8	32	30	39	51.5	PT 1/2	
BCF-20-06R	20	17	8	36	36	41	53.5	PT 3/4	
BCF-22-06R	22	18	9	36	36	41	53.5	PT 3/4	
BCF-25-06R	25	20	10	41	36	41	54.5	PT 3/4	
BCF-25-08R	25	20	10	41	46	45	58.5	PT 1	
BCF-28-08R	28	22	10	46	46	47	61	PT 1	
BCF-30-08R	30	25	10	46	46	47	61.5	PT 1	
BCF-30-10R	30	25	10	46	55	51	65.5	PT 1-1/4	
BCF-32-10R	32	26	11	50	55	51	65.5	PT 1-1/4	
BCF-35-10R	35	28	11	55	55	51	68.5	PT 1-1/4	
BCF-38-12R	38	32	12	60	65	51	70.5	PT 1-1/2	
BCF-40-12R	40	32	12	60	65	55	74.5	PT 1-1/2	
BCF-42-12R	42	34	12	60	65	55	74.5	PT 1-1/2	
BCF-50-16R	50	40	12	75	80	60	81.5	PT 2	
BCF-6A-02R	1/8 10.5	8	7	19	19	30	41.5	PT 1/4	
BCF-8A-03R	1/4 13.8	11	7.5	24	24	34	46	PT 3/8	
BCF-10A-04R	3/8 17.3	14	8	32	30	39	51.5	PT 1/2	
BCF-15A-06R	1/2 21.7	18	9	36	36	41	53.5	PT 3/4	
BCF-20A-08R	3/4 27.2	22	10	46	46	47	61	PT 1	
BCF-25A-10R	1 34.0	28	11	55	55	51	68.5	PT 1-1/4	
BCF-32A-12R	1-1/4 42.7	34	12	65	65	55	78.5	PT 1-1/2	
BCF-40A-16R	1-1/2 48.6	40	12	75	80	60	81.5	PT 2	

BBCF

Bulkhead Female Connector

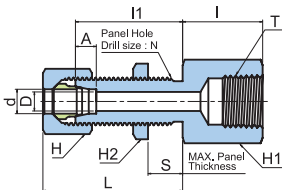
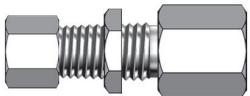

Part No.	Tube OD		Dimension									
	D	d	A	H	H1	H2	I	I1	L	S	N	T
BBCF-06-01R	6	4	7	14	17	17	13	32	42.5	13	12.5	PT 1/8
BBCF-08-02R	8	6	7	17	19	19	18	32	42.5	13	14.5	PT 1/4
BBCF-10-02R	10	8	7	19	19	22	18	32	43.5	13	16.5	PT 1/4
BBCF-10-03R	10	8	7	19	24	22	20	32	43.5	13	16.5	PT 3/8
BBCF-12-02R	12	10	7	22	19	24	18	32	43.5	13	18.5	PT 1/4
BBCF-12-03R	12	10	7	22	24	24	20	32	43.5	13	18.5	PT 3/8
BBCF-15-03R	15	12	7.5	27	24	27	20	37	49.5	15	22.5	PT 3/8
BBCF-15-04R	15	12	7.5	27	30	27	25	37	49.5	15	22.5	PT 1/2
BBCF-16-04R	16	13	7.5	30	30	30	25	37	49.5	15	24.5	PT 1/2
BBCF-18-04R	18	14	8	32	30	32	25	39	51.5	15	26.5	PT 1/2
BBCF-20-06R	20	17	8	36	36	32	27	39	51.5	15	28.5	PT 3/4
BBCF-22-06R	22	18	9	36	36	36	27	39	51.5	15	30.5	PT 3/4
BBCF-25-06R	25	20	10	41	41	41	27	39	52.5	15	35.5	PT 3/4
BBCF-25-08R	25	20	10	41	46	41	31	39	52.5	15	35.5	PT 1
BBCF-28-08R	28	22	10	46	46	46	31	41	55	15	38.5	PT 1
BBCF-30-08R	30	25	10	46	46	46	31	41	55.5	15	40.5	PT 1
BBCF-30-10R	30	25	10	46	55	46	35	41	55.5	15	40.5	PT 1-1/4
BBCF-32-10R	32	26	11	50	55	46	35	43	57.5	15	42.5	PT 1-1/4

- Dimensions and Drawings are for reference only and are subject to change without prior notice.
- Unless otherwise specified, all dimensions are in millimeters.
- Sizes, pressure classes, and end connections not listed are available upon request.
- Length given approximate figure with tightened nut.

BFGC

Female Gauge Connector

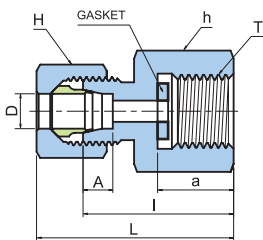
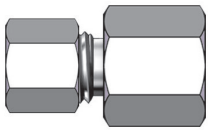

Part No.	Tube OD D	Dimension						
		d	A	H	h	l	L	T
BFGC-04-02G	4	14	6	12	19	29	36.5	PF 1/4
BFGC-04-03G	4	15	6	12	24	30	37.5	PF 3/8
BFGC-06-02G	6	14	7	14	19	32	42.5	PF 1/4
BFGC-06-03G	6	15	7	14	24	34	44.5	PF 3/8
BFGC-06-04G	6	16	7	14	30	36	46.5	PF 1/2
BFGC-08-02G	8	14	7	17	19	32	42.5	PF 1/4
BFGC-08-03G	8	15	7	17	24	34	44.5	PF 3/8
BFGC-08-04G	8	16	7	17	30	36	46.5	PF 1/2
BFGC-10-02G	10	14	7	19	19	32	43.5	PF 1/4
BFGC-10-03G	10	15	7	19	24	34	45.5	PF 3/8
BFGC-10-04G	10	16	7	19	30	36	47.5	PF 1/2
BFGC-12-02G	12	14	7	22	19	32	43.5	PF 1/4
BFGC-12-03G	12	15	7	22	24	34	45.5	PF 3/8
BFGC-12-04G	12	16	7	22	30	36	47.5	PF 1/2

BFE

Female Elbow

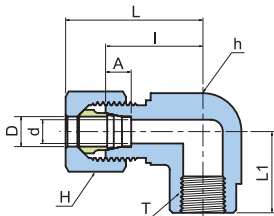
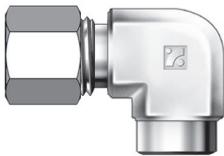

Part No.	Tube OD D	Dimension							
		d	A	H	h	l	L	L1	T
BFE-08-02R	8	6	7	17	19	24	34.5	24	PT 1/4
BFE-10-02R	10	8	7	19	19	24	35.5	24	PT 1/4
BFE-12-02R	12	10	7	22	19	24	35.5	24	PT 1/4
BFE-12-03R	12	10	7	22	24	29	40.5	29	PT 3/8
BFE-15-03R	15	12	7.5	27	24	29	41.5	29	PT 3/8
BFE-15-04R	15	12	7.5	27	30	33	45.5	33	PT 1/2
BFE-16-04R	16	13	7.5	30	30	33	45.5	33	PT 1/2
BFE-18-04R	18	14	8	32	30	33	45.5	33	PT 1/2
BFE-20-06R	20	17	8	36	36	36	48.5	36	PT 3/4
BFE-22-06R	22	18	9	36	36	36	48.5	36	PT 3/4
BFE-25-06R	25	20	10	41	36	36	49.5	36	PT 3/4
BFE-25-08R	25	20	10	41	46	46	59.5	46	PT 1
BFE-28-08R	28	22	10	46	46	46	60	46	PT 1
BFE-30-10R	30	25	10	46	55	55	69.5	55	PT 1-1/4
BFE-32-10R	32	26	11	50	55	55	69.5	55	PT 1-1/4
BFE-35-10R	35	28	11	55	55	55	72.5	55	PT 1-1/4

- Dimensions and Drawings are for reference only and are subject to change without prior notice.
- Unless otherwise specified, all dimensions are in millimeters.
- Sizes, pressure classes, and end connections not listed are available upon request.
- Length given approximate figure with tightened nut.

BFBT

Female Branch Tee

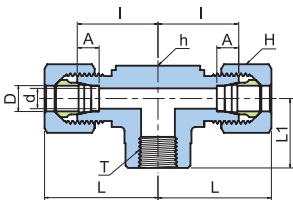

Part No.	Tube OD		Dimension							
	D		d	A	H	h	l	L	L1	T
BFBT-08-02R	8		6	7	17	19	24	34.5	24	PT 1/4
BFBT-10-02R	10		8	7	19	19	24	35.5	24	PT 1/4
BFBT-12-02R	12		10	7	22	19	24	35.5	24	PT 1/4
BFBT-12-03R	12		10	7	22	24	29	40.5	29	PT 3/8
BFBT-15-03R	15		12	7.5	27	24	29	41.5	29	PT 3/8
BFBT-15-04R	15		12	7.5	27	30	33	45.5	33	PT 1/2
BFBT-16-04R	16		13	7.5	30	30	33	45.5	33	PT 1/2
BFBT-18-04R	18		14	8	32	30	33	45.5	33	PT 1/2
BFBT-20-06R	20		17	8	36	36	36	48.5	36	PT 3/4
BFBT-22-06R	22		18	9	36	36	36	48.5	36	PT 3/4
BFBT-25-06R	25		20	10	41	36	36	49.5	36	PT 3/4
BFBT-25-08R	25		20	10	41	46	46	59.5	46	PT 1
BFBT-28-08R	28		22	10	46	46	46	60	46	PT 1
BFBT-30-08R	30		25	10	46	46	46	60.5	46	PT 1
BFBT-30-10R	30		25	10	46	55	55	69.5	55	PT 1-1/4
BFBT-32-10R	32		26	11	50	55	55	69.5	55	PT 1-1/4
BFBT-35-10R	35		28	11	55	55	55	72.5	55	PT 1-1/4
BFBT-6A-02R	1/8	10.5	8	7	19	19	24	35.5	24	PT 1/4
BFBT-8A-03R	1/4	13.8	11	7.5	24	24	29	41	29	PT 3/8
BFBT-10A-04R	3/8	17.3	14	8	32	30	33	45.5	33	PT 1/2
BFBT-15A-06R	1/2	21.7	18	9	36	36	36	48.5	36	PT 3/4
BFBT-20A-08R	3/4	27.2	22	10	46	46	46	60	46	PT 1
BFBT-25A-10R	1	34.0	28	11	55	55	55	72.5	55	PT 1-1/4

BFRT

Female Run Tee

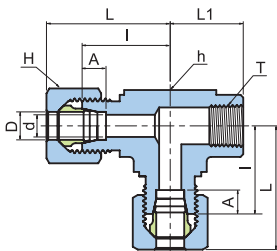
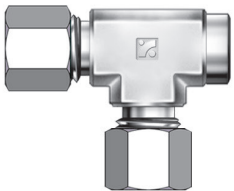

Part No.	Tube OD		Dimension							
	D		d	A	H	h	l	L	L1	T
BFRT-08-02R	8		6	7	17	19	24	34.5	24	PT 1/4
BFRT-10-02R	10		8	7	19	19	24	35.5	24	PT 1/4
BFRT-12-02R	12		10	7	22	19	24	35.5	24	PT 1/4
BFRT-12-03R	12		10	7	22	24	29	40.5	29	PT 3/8
BFRT-15-03R	15		12	7.5	27	24	29	41.5	29	PT 3/8
BFRT-15-04R	15		12	7.5	27	30	33	45.5	33	PT 1/2
BFRT-16-04R	16		13	7.5	30	30	33	45.5	33	PT 1/2
BFRT-18-04R	18		14	8	32	30	33	45.5	33	PT 1/2
BFRT-20-06R	20		17	8	36	36	36	48.5	36	PT 3/4
BFRT-22-06R	22		18	9	36	36	36	48.5	36	PT 3/4
BFRT-25-06R	25		20	10	41	36	36	49.5	36	PT 3/4
BFRT-25-08R	25		20	10	41	46	46	59.5	46	PT 1
BFRT-28-08R	28		22	10	46	46	46	60	46	PT 1
BFRT-30-08R	30		25	10	46	46	46	60.5	46	PT 1
BFRT-30-10R	30		25	10	46	55	55	69.5	55	PT 1-1/4
BFRT-32-10R	32		26	11	50	55	55	69.5	55	PT 1-1/4
BFRT-35-10R	35		28	11	55	55	55	72.5	55	PT 1-1/4
BFRT-6A-02R	1/8	10.5	8	7	19	19	24	35.5	24	PT 1/4
BFRT-8A-03R	1/4	13.8	11	7.5	24	24	29	41	29	PT 3/8
BFRT-10A-04R	3/8	17.3	14	8	32	30	33	45.5	33	PT 1/2
BFRT-15A-06R	1/2	21.7	18	9	36	36	36	48.5	36	PT 3/4
BFRT-20A-08R	3/4	27.2	22	10	46	46	46	60	46	PT 1
BFRT-25A-10R	1	34.0	28	11	55	55	55	72.5	55	PT 1-1/4

- Dimensions and Drawings are for reference only and are subject to change without prior notice.
- Unless otherwise specified, all dimensions are in millimeters.
- Sizes, pressure classes, and end connections not listed are available upon request.
- Length given approximate figure with tightened nut.

BC
Cap

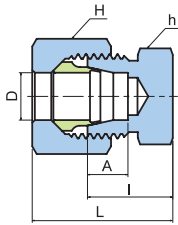
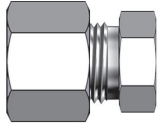

Part No.	Tube OD D	Dimension				
		A	H	h	I	L
BC-06	6	7	14	14	18	28.5
BC-08	8	7	17	17	19	29.5
BC-10	10	7	19	17	20	31.5
BC-12	12	7	22	19	20	31.5
BC-15	15	7.5	27	24	22	34.5
BC-16	16	7.5	30	27	24	36.5
BC-18	18	8	32	27	24	36.5
BC-20	20	8	36	30	24	36.5
BC-22	22	9	36	32	25	37.5
BC-25	25	10	41	36	25	38.5
BC-28	28	10	46	41	28	42
BC-30	30	10	46	41	28	42.5
BC-32	32	11	50	46	30	44.5

BPL
Plug

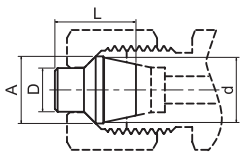
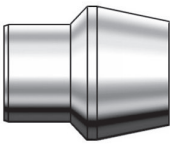

Part No.	Tube OD D	Dimension		
		A	d	L
BPL-06	6	9	8	13.5
BPL-08	8	11	10	13.5
BPL-10	10	13	12	14.5
BPL-12	12	15	14	14.5
BPL-15	15	18	17	16
BPL-16	16	19	18	16
BPL-18	18	21	20	17.5
BPL-20	20	23	22	17.5
BPL-22	22	25	24	17.5
BPL-25	25	28.5	27.4	19
BPL-28	28	31.5	30.4	19
BPL-30	30	33.5	32.4	20
BPL-32	32	35.5	34.4	20

- Dimensions and Drawings are for reference only and are subject to change without prior notice.
- Unless otherwise specified, all dimensions are in millimeters.
- Sizes, pressure classes, and end connections not listed are available upon request.
- Length given approximate figure with tightened nut.

BNT

Nut

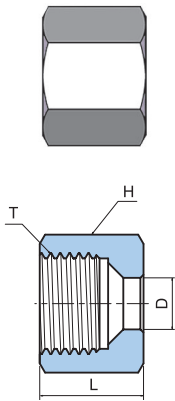

Part No.	Tube OD		Dimension		
	D		H	L	T
BNT-04	4		12	10.5	M10 X 1.25
BNT-06	6		14	15	M12 X 1.5
BNT-08	8		17	15	M14 X 1.5
BNT-10	10		19	16	M16 X 1.5
BNT-12	12		22	16	M18 X 1.5
BNT-15	15		27	19	M22 X 1.5
BNT-16	16		30	19	M24 X 1.5
BNT-18	18		32	19	M26 X 1.5
BNT-20	20		36	19	M28 X 1.5
BNT-22	22		36	19	M30 X 1.5
BNT-25	25		41	20	M35 X 1.5
BNT-28	28		46	21	M38 X 1.5
BNT-30	30		46	22	M40 X 1.5
BNT-32	32		50	22	M42 X 1.5
BNT-35	35		55	25	M45 X 1.5
BNT-38	38		60	27	M48 X 1.5
BNT-40	40		60	29.5	M52 X 2
BNT-42	42		60	29.5	M52 X 2
BNT-50	50		75	31.5	M64 X 2
BNT-6A	1/8	10.5	19	16	M16 X 1.5
BNT-8A	1/4	13.8	24	18	M20 X 1.5
BNT-10A	3/8	17.3	32	19	M26 X 1.5
BNT-15A	1/2	21.7	36	19	M30 X 1.5
BNT-20A	3/4	27.2	46	21	M38 X 1.5
BNT-25A	1	34.0	55	25	M45 X 1.5
BNT-32A	1-1/4	42.7	65	30.5	M56 X 2
BNT-40A	1-1/2	48.6	75	31.5	M64 X 2

BCR

Sleeve

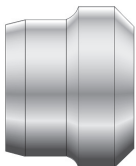

Part No.	Tube OD D	L	Part No.	Tube OD D	L
BCR-04	4	7	BS-35	35	14
BCR-06	6	9	BS-38	38	14
BCR-08	8	9	BS-40	40	14
BCR-10	10	10	BS-42	42	14
BCR-12	12	10	BS-50	50	14
BCR-15	15	10	BS-6A	1/8 10.5	10
BCR-16	16	10	BS-8A	1/4 13.8	10
BCR-18	18	10	BS-10A	3/8 17.3	10
BCR-20	20	10	BS-15A	1/2 21.7	10
BCR-22	22	10	BS-20A	3/4 27.2	11
BCR-25	25	11	BS-25A	1 34.0	14
BCR-28	28	11	BS-30A	1-1/4 42.7	14
BCR-30	30	11	BS-40A	1-1/2 48.6	14
BCR-32	32	11			

- Dimensions and Drawings are for reference only and are subject to change without prior notice.
- Unless otherwise specified, all dimensions are in millimeters.
- Sizes, pressure classes, and end connections not listed are available upon request.
- Length given approximate figure with tightened nut.

BHMU

Hose
Male Union

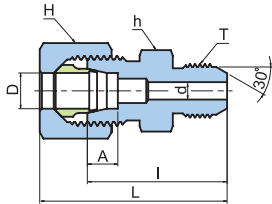
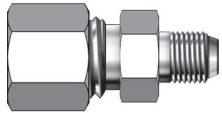

Part No.	Tube OD D	Dimension						
		d	A	H	h	I	L	T
BHMU-08-02G	8	6	7	17	17	35	45.5	PF 1/4
BHMU-08-03G	8	6	7	17	19	37	47.5	PF 3/8
BHMU-10-02G	10	6	7	19	17	35	46.5	PF 1/4
BHMU-10-03G	10	8	7	19	19	37	48.5	PF 3/8
BHMU-10-04G	10	8	7	19	22	40	51.5	PF 1/2
BHMU-12-02G	12	6	7	22	19	35	46.5	PF 1/4
BHMU-12-03G	12	9	7	22	19	37	48.5	PF 3/8
BHMU-12-04G	12	10	7	22	22	40	51.5	PF 1/2
BHMU-15-03G	15	9	7.5	27	24	40	52.5	PF 3/8
BHMU-15-04G	15	12	7.5	27	24	42	54.5	PF 1/2
BHMU-16-03G	16	9	7.5	30	27	40	52.5	PF 3/8
BHMU-16-04G	16	12	7.5	30	27	42	54.5	PF 1/2
BHMU-18-04G	18	12	8	32	27	42	54.5	PF 1/2
BHMU-20-06G	20	16	8	36	30	46	58.5	PF 3/4
BHMU-22-04G	22	12	9	36	32	44	56.5	PF 1/2
BHMU-22-06G	22	16	9	36	32	46	58.5	PF 3/4
BHMU-25-06G	25	16	10	41	36	47	60.5	PF 3/4
BHMU-25-08G	25	20	10	41	36	49	62.5	PF 1
BHMU-28-06G	28	16	10	46	41	49	63	PF 3/4
BHMU-28-08G	28	22	10	46	41	51	65	PF 1
BHMU-30-06G	30	16	10	46	41	49	63.5	PF 3/4
BHMU-30-08G	30	22	10	46	41	51	65.5	PF 1
BHMU-32-08G	32	22	11	50	46	52	66.5	PF 1
BHMU-32-10G	32	28	11	50	46	56	70.5	PF 1-1/4

BHFU

Hose
Female Union

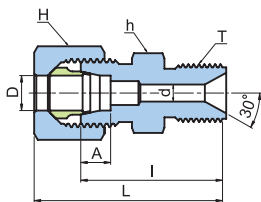
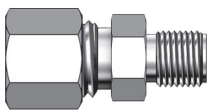

Part No.	Tube OD D	Dimension						
		d	A	H	h	I	L	T
BHFU-08-02G	8	6	7	17	17	33	43.5	PF 1/4
BHFU-08-03G	8	6	7	17	19	34	44.5	PF 3/8
BHFU-10-02G	10	6	7	19	17	33	44.5	PF 1/4
BHFU-10-03G	10	8	7	19	19	34	45.5	PF 3/8
BHFU-10-04G	10	8	7	19	22	38	49.5	PF 1/2
BHFU-12-02G	12	6	7	22	19	33	44.5	PF 1/4
BHFU-12-03G	12	9	7	22	19	34	45.5	PF 3/8
BHFU-12-04G	12	10	7	22	22	38	49.5	PF 1/2
BHFU-15-03G	15	9	7.5	27	24	37	49.5	PF 3/8
BHFU-15-04G	15	12	7.5	27	24	40	52.5	PF 1/2
BHFU-16-03G	16	9	7.5	30	27	37	49.5	PF 3/8
BHFU-16-04G	16	12	7.5	30	27	40	52.5	PF 1/2
BHFU-18-04G	18	12	8	32	27	40	52.5	PF 1/2
BHFU-20-06G	20	16	8	36	30	43	55.5	PF 3/4
BHFU-22-04G	22	12	9	36	32	42	54.5	PF 1/2
BHFU-22-06G	22	16	9	36	32	43	55.5	PF 3/4
BHFU-25-06G	25	16	10	41	36	44	57.5	PF 3/4
BHFU-25-08G	25	20	10	41	36	46	59.5	PF 1
BHFU-28-06G	28	16	10	46	41	46	60	PF 3/4
BHFU-28-08G	28	22	10	46	41	48	62	PF 1
BHFU-30-06G	30	16	10	46	41	46	60.5	PF 3/4
BHFU-30-08G	30	22	10	46	41	48	62.5	PF 1
BHFU-32-08G	32	22	11	50	46	49	63.5	PF 1
BHFU-32-10G	32	28	11	50	46	55	69.5	PF 1-1/4
BHFU-38-12G	38	32	12	60	50	57	76.5	PF 1-1/2
BHFU-40-12G	40	32	12	60	55	62	81.5	PF 1-1/2
BHFU-50-16G	50	40	12	75	65	70	91.5	PF 2

- Dimensions and Drawings are for reference only and are subject to change without prior notice.
- Unless otherwise specified, all dimensions are in millimeters.
- Sizes, pressure classes, and end connections not listed are available upon request.
- Length given approximate figure with tightened nut.

BHBMU

Hose Bulkhead
Male Union

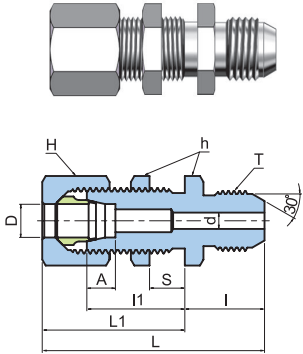

Part No.	Tube OD D	Dimension								Panel Hole Drill Size	Max. Panel Thickness S	T
		d	A	H	h	I	I1	L	L1			
BHBMU-08-02G	8	6	7	17	19	23	32	65.5	42.5	14.5	13	PF 1/4
BHBMU-08-03G	8	6	7	17	19	25	32	67.5	42.5	14.5	13	PF 3/8
BHBMU-10-02G	10	6	7	19	22	24	32	67.5	43.5	16.5	13	PF 1/4
BHBMU-10-03G	10	8	7	19	22	26	32	69.5	43.5	16.5	13	PF 3/8
BHBMU-10-04G	10	8	7	19	22	28	32	71.5	43.5	16.5	13	PF 1/2
BHBMU-12-02G	12	6	7	22	24	24	32	67.5	43.5	18.5	13	PF 1/4
BHBMU-12-03G	12	9	7	22	24	26	32	69.5	43.5	18.5	13	PF 3/8
BHBMU-12-04G	12	10	7	22	24	28	32	71.5	43.5	18.5	13	PF 1/2
BHBMU-15-03G	15	9	7.5	27	27	26	37	75.5	49.5	22.5	15	PF 3/8
BHBMU-15-04G	15	12	7.5	27	27	28	37	77.5	49.5	22.5	15	PF 1/2
BHBMU-16-03G	16	9	7.5	30	30	28	37	77.5	49.5	24.5	15	PF 3/8
BHBMU-16-04G	16	12	7.5	30	30	30	37	79.5	49.5	24.5	15	PF 1/2
BHBMU-18-04G	18	12	8	32	32	30	39	81.5	51.5	26.5	15	PF 1/2
BHBMU-20-06G	20	16	8	36	32	32	39	83.5	51.5	28.5	15	PF 3/4
BHBMU-22-04G	22	12	9	36	36	31	39	82.5	51.5	30.5	15	PF 1/2
BHBMU-22-06G	22	16	9	36	36	33	39	84.5	51.5	30.5	15	PF 3/4
BHBMU-25-06G	25	16	10	41	41	33	39	87.5	52.5	35.5	15	PF 3/4
BHBMU-25-08G	25	20	10	41	41	35	39	89.5	52.5	35.5	15	PF 1
BHBMU-28-06G	28	16	10	46	46	34	41	89	55	38.5	15	PF 3/4
BHBMU-28-08G	28	22	10	46	46	36	41	91	55	38.5	15	PF 1
BHBMU-30-06G	30	16	10	46	46	34	41	89.5	55.5	40.5	15	PF 3/4
BHBMU-30-08G	30	22	10	46	46	36	41	91.5	55.5	40.5	15	PF 1
BHBMU-32-08G	32	22	11	50	50	38	43	95.5	57.5	42.5	15	PF 1
BHBMU-32-10G	32	28	11	50	50	42	43	99.5	57.5	42.5	15	PF 1-1/4

BHBFU

Hose Bulkhead
Female Union

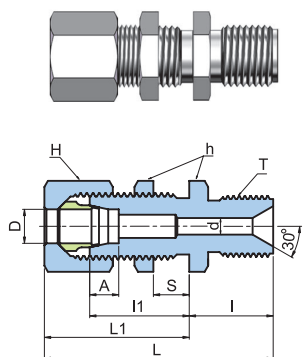

Part No.	Tube OD D	Dimension								Panel Hole Drill Size	Max. Panel Thickness S	T
		d	A	H	h	I	I1	L	L1			
BHBFU-08-02G	8	6	7	17	19	21	32	63.5	42.5	14.5	13	PF 1/4
BHBFU-08-03G	8	6	7	17	19	22	32	64.5	42.5	14.5	13	PF 3/8
BHBFU-10-02G	10	6	7	19	22	22	32	65.5	43.5	16.5	13	PF 1/4
BHBFU-10-03G	10	8	7	19	22	23	32	66.5	43.5	16.5	13	PF 3/8
BHBFU-10-04G	10	8	7	19	22	26	32	69.5	43.5	16.5	13	PF 1/2
BHBFU-12-02G	12	6	7	22	24	22	32	65.5	43.5	18.5	13	PF 1/4
BHBFU-12-03G	12	9	7	22	24	23	32	66.5	43.5	18.5	13	PF 3/8
BHBFU-12-04G	12	10	7	22	24	26	32	69.5	43.5	18.5	13	PF 1/2
BHBFU-15-03G	15	9	7.5	27	27	23	37	72.5	49.5	22.5	15	PF 3/8
BHBFU-15-04G	15	12	7.5	27	27	26	37	75.5	49.5	22.5	15	PF 1/2
BHBFU-16-03G	16	9	7.5	30	30	25	37	74.5	49.5	24.5	15	PF 3/8
BHBFU-16-04G	16	12	7.5	30	30	28	37	77.5	49.5	24.5	15	PF 1/2
BHBFU-18-04G	18	12	8	32	32	28	39	79.5	51.5	26.5	15	PF 1/2
BHBFU-20-06G	20	16	8	36	32	29	39	80.5	51.5	28.5	15	PF 3/4
BHBFU-22-04G	22	12	9	36	36	29	39	80.5	51.5	30.5	15	PF 1/2
BHBFU-22-06G	22	16	9	36	36	30	39	81.5	51.5	30.5	15	PF 3/4
BHBFU-25-06G	25	16	10	41	41	30	39	82.5	52.5	35.5	15	PF 3/4
BHBFU-25-08G	25	20	10	41	41	32	39	84.5	52.5	35.5	15	PF 1
BHBFU-28-06G	28	16	10	46	46	31	41	86	55	38.5	15	PF 3/4
BHBFU-28-08G	28	22	10	46	46	33	41	88	55	38.5	15	PF 1
BHBFU-30-06G	30	16	10	46	46	31	41	86.5	55.5	40.5	15	PF3/4
BHBFU-30-08G	30	22	10	46	46	33	41	88.5	55.5	40.5	15	PF 1
BHBFU-32-08G	32	22	11	50	50	35	43	92.5	57.5	42.5	15	PF 1
BHBFU-32-10G	32	28	11	50	50	41	43	98.5	57.5	42.5	15	PF 1-1/4
BHBFU-38-12G	38	31	12	60	55	42	45	106.5	64.5	48.5	15	PF 1-1/2
BHBFU-40-12G	40	32	12	60	60	44	50	113.5	69.5	52.5	15	PF 1-1/2
BHBFU-50-16G	50	40	12	75	70	53	50	124.5	71.5	64.5	15	PF 2

- Dimensions and Drawings are for reference only and are subject to change without prior notice.
- Unless otherwise specified, all dimensions are in millimeters.
- Sizes, pressure classes, and end connections not listed are available upon request.
- Length given approximate figure with tightened nut.

BHME

Hose
Male Elbow

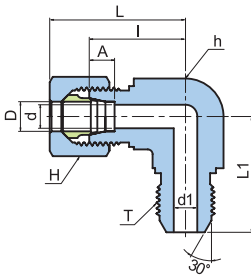
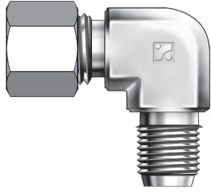

Part No.	Tube OD D	Dimension								
		d	d1	A	H	h	I	L	L1	T
BHME-08-02G	8	6	6	7	17	17	23	33.5	25	PF 1/4
BHME-08-03G	8	6	9	7	17	19	24	34.5	28	PF 3/8
BHME-10-02G	10	8	6	7	19	19	24	35.5	28	PF 1/4
BHME-10-03G	10	8	9	7	19	19	24	35.5	28	PF 3/8
BHME-10-04G	10	8	12	7	19	24	29	40.5	34	PF 1/2
BHME-12-02G	12	10	6	7	22	19	24	35.5	28	PF 1/4
BHME-12-03G	12	10	9	7	22	19	24	35.5	28	PF 3/8
BHME-12-04G	12	10	12	7	22	24	29	40.5	34	PF 1/2
BHME-15-03G	15	12	9	7.5	27	24	29	41.5	33	PF 3/8
BHME-15-04G	15	12	12	7.5	27	24	29	41.5	34	PF 1/2
BHME-16-03G	16	13	9	7.5	30	27	32	44.5	36	PF 3/8
BHME-16-04G	16	13	12	7.5	30	27	32	44.5	38	PF 1/2
BHME-18-04G	18	14	12	8	32	27	32	44.5	38	PF 1/2
BHME-20-06G	20	17	16	8	36	30	33	45.5	41	PF 3/4
BHME-22-04G	22	18	12	9	36	32	34	46.5	40	PF 1/2
BHME-22-06G	22	18	16	9	36	32	34	46.5	42	PF 3/4
BHME-25-06G	25	20	16	10	41	36	36	49.5	44	PF 3/4
BHME-25-08G	25	20	20	10	41	36	36	49.5	46	PF 1
BHME-28-06G	28	22	16	10	46	41	41	55	47	PF 3/4
BHME-28-08G	28	22	22	10	46	41	41	55	49	PF 1
BHME-30-06G	30	25	16	10	46	41	41	55.5	47	PF 3/4
BHME-30-08G	30	25	22	10	46	41	41	55.5	49	PF 1
BHME-32-08G	32	26	22	11	50	46	46	60.5	54	PF 1
BHME-32-10G	32	26	28	11	50	46	46	60.5	56	PF 1-1/4

BHFE

Hose
Female Elbow

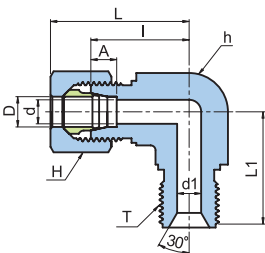
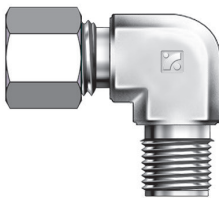

Part No.	Tube OD D	Dimension								
		d	d1	A	H	h	I	L	L1	T
BHFE-08-02G	8	6	6	7	17	17	23	33.5	25	PF 1/4
BHFE-08-03G	8	6	9	7	17	19	24	34.5	27	PF 3/8
BHFE-10-02G	10	8	6	7	19	19	24	35.5	26	PF 1/4
BHFE-10-03G	10	8	9	7	19	19	24	35.5	27	PF 3/8
BHFE-10-04G	10	8	12	7	19	24	29	40.5	33	PF 1/2
BHFE-12-02G	12	10	6	7	22	19	24	35.5	26	PF 1/4
BHFE-12-03G	12	10	9	7	22	19	24	35.5	27	PF 3/8
BHFE-12-04G	12	10	12	7	22	24	29	40.5	33	PF 1/2
BHFE-15-03G	15	12	9	7.5	27	24	29	41.5	30	PF 3/8
BHFE-15-04G	15	12	12	7.5	27	24	29	41.5	33	PF 1/2
BHFE-16-03G	16	13	9	7.5	30	27	32	44.5	33	PF 3/8
BHFE-16-04G	16	13	12	7.5	30	27	32	44.5	36	PF 1/2
BHFE-18-04G	18	14	12	8	32	27	32	44.5	36	PF 1/2
BHFE-20-06G	20	17	16	8	36	30	33	45.5	38	PF 3/4
BHFE-22-04G	22	18	12	9	36	32	34	46.5	38	PF 1/2
BHFE-22-06G	22	18	16	9	36	32	34	46.5	39	PF 3/4
BHFE-25-06G	25	20	16	10	41	36	36	49.5	41	PF 3/4
BHFE-25-08G	25	20	20	10	41	36	36	49.5	43	PF 1
BHFE-28-06G	28	22	16	10	46	41	41	55	44	PF 3/4
BHFE-28-08G	28	22	22	10	46	41	41	55	46	PF 1
BHFE-30-06G	30	25	16	10	46	41	41	55.5	44	PF 3/4
BHFE-30-08G	30	25	22	10	46	41	41	55.5	46	PF 1
BHFE-32-08G	32	26	22	11	50	46	46	60.5	51	PF 1
BHFE-32-10G	32	26	28	11	50	46	46	60.5	57	PF 1-1/4
BHFE-38-12G	38	32	34	12	60	50	50	69.5	61	PF 1-1/2
BHFE-40-12G	40	32	34	12	60	55	55	74.5	62	PF 1-1/2
BHFE-50-16G	50	40	46	12	75	65	62	83.5	72	PF 2

- Dimensions and Drawings are for reference only and are subject to change without prior notice.
- Unless otherwise specified, all dimensions are in millimeters.
- Sizes, pressure classes, and end connections not listed are available upon request.
- Length given approximate figure with tightened nut.

BHBME

Hose Bulkhead
Male Elbow

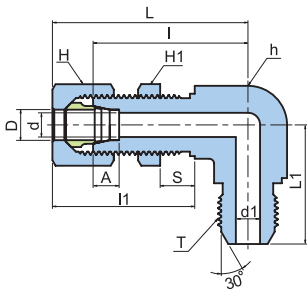
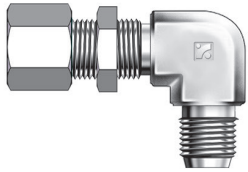

Part No.	Tube OD D	Dimension										Panel Hole Drill Size	Max. Panel Thickness S	T
		d	d1	A	H	H1	h	I	I1	L	L1			
BHBME-08-02G	8	6	6	7	17	19	19	46	42.5	56.5	28	14.5	13	PF 1/4
BHBME-08-03G	8	6	9	7	17	19	19	46	42.5	56.5	30	14.5	13	PF 3/8
BHBME-10-02G	10	8	6	7	19	22	22	48	43.5	59.5	28	16.5	13	PF 1/4
BHBME-10-03G	10	8	9	7	19	22	22	48	43.5	59.5	30	16.5	13	PF 3/8
BHBME-10-04G	10	8	12	7	19	22	24	49	43.5	60.5	35	16.5	13	PF 1/2
BHBME-12-02G	12	10	6	7	22	24	24	49	43.5	60.5	31	18.5	13	PF 1/4
BHBME-12-03G	12	10	9	7	22	24	24	49	43.5	60.5	33	18.5	13	PF 3/8
BHBME-12-04G	12	10	12	7	22	24	24	49	43.5	60.5	35	18.5	13	PF 1/2
BHBME-15-03G	15	12	9	7.5	27	27	27	57	49.5	69.5	36	22.5	15	PF 3/8
BHBME-15-04G	15	12	12	7.5	27	27	27	57	49.5	69.5	37	22.5	15	PF 1/2
BHBME-16-03G	16	13	9	7.5	30	30	30	59	49.5	71.5	37	24.5	15	PF 3/8
BHBME-16-04G	16	13	12	7.5	30	30	30	59	49.5	71.5	38	24.5	15	PF 1/2
BHBME-18-04G	18	14	12	8	32	32	32	63	51.5	75.5	39	26.5	15	PF 1/2
BHBME-20-06G	20	16	16	8	36	32	32	65	51.5	77.5	40	28.5	15	PF 3/4
BHBME-22-04G	22	18	12	9	36	36	36	65	51.5	77.5	40	30.5	15	PF 1/2
BHBME-22-06G	22	18	16	9	38	36	36	65	51.5	77.5	40	30.5	15	PF 3/4
BHBME-25-06G	25	20	16	10	41	41	41	68	52.5	81.5	43	35.5	15	PF 3/4
BHBME-25-08G	25	20	20	10	41	41	41	68	52.5	81.5	43	35.5	15	PF 1
BHBME-28-06G	28	22	16	10	46	46	46	74	55	88	48	38.5	15	PF 3/4
BHBME-28-08G	28	22	22	10	46	46	46	74	55	88	48	38.5	15	PF 1
BHBME-30-06G	30	25	16	10	46	46	46	74	55.5	88.5	48	40.5	15	PF 3/4
BHBME-30-08G	30	25	22	10	46	46	46	74	55.5	88.5	48	40.5	15	PF 1

BHBFE

Hose Bulkhead
Female Elbow

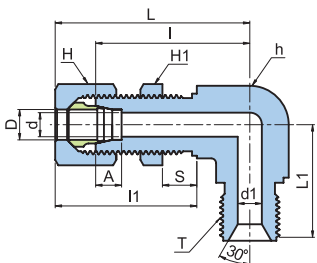
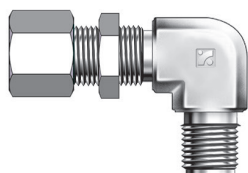

Part No.	Tube OD D	Dimension										Panel Hole Drill Size	Max. Panel Thickness S	T
		d	d1	A	H	H1	h	I	I1	L	L1			
BHBFE-08-02G	8	6	6	7	17	19	19	46	42.5	56.5	26	14.5	13	PF 1/4
BHBFE-08-03G	8	6	9	7	17	19	19	46	42.5	56.5	27	14.5	13	PF 3/8
BHBFE-10-02G	10	8	6	7	19	22	22	48	43.5	59.5	28	16.5	13	PF 1/4
BHBFE-10-03G	10	8	9	7	19	22	22	48	43.5	59.5	29	16.5	13	PF 3/8
BHBFE-10-04G	10	8	12	7	19	22	24	49	43.5	60.5	33	16.5	13	PF 1/2
BHBFE-12-02G	12	10	6	7	22	24	24	49	43.5	60.5	30	18.5	13	PF 1/4
BHBFE-12-03G	12	10	9	7	22	24	24	49	43.5	60.5	30	18.5	13	PF 3/8
BHBFE-12-04G	12	10	12	7	22	24	24	49	43.5	60.5	33	18.5	13	PF 1/2
BHBFE-15-03G	15	12	9	7.5	27	27	27	57	49.5	69.5	33	22.5	15	PF 3/8
BHBFE-15-04G	15	12	12	7.5	27	27	27	57	49.5	69.5	36	22.5	15	PF 1/2
BHBFE-16-03G	16	13	9	7.5	30	30	30	59	49.5	71.5	34	24.5	15	PF 3/8
BHBFE-16-04G	16	13	12	7.5	30	30	30	59	49.5	71.5	37	24.5	15	PF 1/2
BHBFE-18-04G	18	14	12	8	32	32	32	63	51.5	75.5	37	26.5	15	PF 1/2
BHBFE-20-06G	20	16	16	8	36	32	32	65	51.5	77.5	40	28.5	15	PF 3/4
BHBFE-22-04G	22	18	12	9	36	36	36	65	51.5	77.5	40	30.5	15	PF 1/2
BHBFE-22-06G	22	18	16	9	36	36	36	65	51.5	77.5	40	30.5	15	PF 3/4
BHBFE-25-06G	25	20	16	10	41	41	41	68	52.5	81.5	43	35.5	15	PF 3/4
BHBFE-25-08G	25	20	20	10	41	41	41	68	52.5	81.5	43	35.5	15	PF 1
BHBFE-28-06G	28	22	16	10	46	46	46	74	55	88	48	38.5	15	PF 3/4
BHBFE-28-08G	28	22	22	10	46	46	46	74	55	88	48	38.5	15	PF 1
BHBFE-30-06G	30	25	16	10	46	46	46	74	55.5	88.5	48	40.5	15	PF 3/4
BHBFE-30-08G	30	25	22	10	46	46	46	74	55.5	88.5	48	40.5	15	PF 1

- Dimensions and Drawings are for reference only and are subject to change without prior notice.
- Unless otherwise specified, all dimensions are in millimeters.
- Sizes, pressure classes, and end connections not listed are available upon request.
- Length given approximate figure with tightened nut.

BWC

Welding
Connector

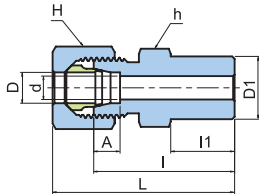
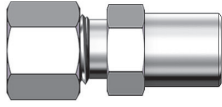

Part No.	Tube OD		Dimension							
	D		D1	d	A	H	h	I	I1	L
BWC-06	6		12	4	7	14	14	29	11	39.5
BWC-08	8		14	6	7	17	17	34	15	44.5
BWC-10	10		16	8	7	19	17	34	15	45.5
BWC-12	12		18	10	7	22	19	34	15	45.5
BWC-15	15		21	12	7.5	27	24	40	18	52.5
BWC-16	16		22	13	7.5	30	27	44	22	56.5
BWC-18	18		25	14	8	32	27	44	22	56.5
BWC-20	20		28	17	8	36	30	46	22	58.5
BWC-22	22		28	18	9	36	32	46	22	58.5
BWC-25	25		33	20	10	41	36	51	26	64.5
BWC-28	28		36	22	10	46	41	55	28	69
BWC-30	30		39	25	10	46	41	55	28	69.5
BWC-32	32		40	26	11	50	46	56	28	70.5
BWC-35	35		43	28	11	55	46	56	28	73.5
BWC-38	38		45	32	12	60	50	58	28	77.5
BWC-40	40		46	32	12	60	55	65	30	84.5
BWC-50	50		57	40	12	75	65	70	30	91.5
BWC-6A	1/8	10.5	16	8	7	19	17	34	15	45.5
BWC-8A	1/4	13.8	19	11	7.5	24	22	40	18	52
BWC-10A	3/8	17.3	24	14	8	32	27	44	22	56.5
BWC-15A	1/2	21.7	28	18	9	36	32	46	22	58.5
BWC-20A	3/4	27.2	33	22	10	46	41	52	25	66
BWC-25A	1	34.0	40	28	11	55	46	56	28	73.5
BWC-32A	1-1/4	42.7	47	34	12	65	60	65	28	85.5
BWC-40A	1-1/2	48.6	55	40	12	75	65	70	30	91.5

BWBU

Welding Bulkhead
Union

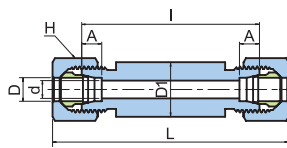

Part No.	Tube OD		Dimension					L
	D		d	A	H	D1	I	
BWBU-06	6		4	7	14	16	74	95
BWBU-08	8		6	7	17	16	74	95
BWBU-10	10		8	7	19	19	74	97
BWBU-12	12		10	7	22	20	74	97
BWBU-15	15		12	7.5	27	25	78	103
BWBU-16	16		13	7.5	30	28	78	103
BWBU-18	18		14	8	32	28	78	103
BWBU-20	20		17	8	36	32	78	103
BWBU-22	22		18	9	36	32	78	103
BWBU-25	25		20	10	41	38	78	105
BWBU-28	28		22	10	46	39	82	110
BWBU-30	30		25	10	46	46	82	111
BWBU-32	32		26	11	50	46	82	111
BWBU-35	35		28	11	55	46	82	117
BWBU-38	38		32	12	60	55	82	121
BWBU-40	40		32	12	60	55	90	129
BWBU-50	50		40	12	75	65	90	133
BWBU-6A	1/8	10.5	8	7	19	19	74	97
BWBU-8A	1/4	13.8	11	7.5	24	22	78	102
BWBU-10A	3/8	17.3	14	8	32	28	78	103
BWBU-15A	1/2	21.7	18	9	36	32	78	103
BWBU-20A	3/4	27.2	22	10	46	39	82	110
BWBU-25A	1	34.0	28	11	55	46	82	117
BWBU-32A	1-1/4	42.7	34	12	65	58	90	131
BWBU-40A	1-1/2	48.6	40	12	75	65	90	133

- Dimensions and Drawings are for reference only and are subject to change without prior notice.
- Unless otherwise specified, all dimensions are in millimeters.
- Sizes, pressure classes, and end connections not listed are available upon request.
- Length given approximate figure with tightened nut.

BAP-R
Adapter

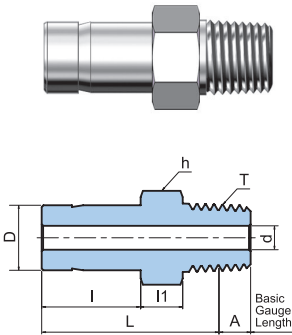

Part No.	Tube OD		Dimension						
	D		d	A	h	I	I1	L	T
BAP-06-01R	6		3	3.97	12	20	6	32	PT 1/8
BAP-08-02R	8		5	6.01	14	20	7	35	PT 1/4
BAP-10-02R	10		6	6.01	14	21	7	36	PT 1/4
BAP-10-03R	10		6	6.35	19	21	7	36.5	PT 3/8
BAP-12-02R	12		7	6.01	14	22	7	37	PT 1/4
BAP-12-03R	12		8	6.35	19	22	7	37.5	PT 3/8
BAP-15-03R	15		8	6.35	19	24	8	40.5	PT 3/8
BAP-15-04R	15		10	8.16	22	24	8	43	PT 1/2
BAP-16-04R	16		11	8.16	22	24	8	43	PT 1/2
BAP-18-04R	18		12	8.16	22	24	8	43	PT 1/2
BAP-20-06R	20		14	9.53	27	25	10	46.5	PT 3/4
BAP-22-06R	22		14	9.53	27	26	10	47.5	PT 3/4
BAP-25-06R	25		16	9.53	27	28	10	49.5	PT 3/4
BAP-25-08R	25		17	10.39	36	28	11	52.5	PT 1
BAP-28-08R	28		18	10.39	36	28	11	52.5	PT 1
BAP-30-08R	30		20	10.39	36	29	11	53.5	PT 1
BAP-30-10R	30		20	12.70	46	29	12	55	PT 1-1/4
BAP-32-10R	32		22	12.70	46	30	12	56	PT 1-1/4
BAP-38-12R	38		26	12.70	50	36	14	64.5	PT 1-1/2
BAP-40-12R	40		28	12.70	50	36	14	64	PT 1-1/2
BAP-50-16R	50		34	15.88	65	37	20	72	PT 2
BAP-6A-02R	1/8	10.5	6	6.01	14	21	7	36	PT 1/4
BAP-8A-03R	1/4	13.8	9	6.35	19	22	8	38.5	PT 3/8
BAP-10A-04R	3/8	17.3	11	8.16	22	24	8	43	PT 1/2
BAP-15A-06R	1/2	21.7	14	9.53	27	26	10	47.5	PT 3/4
BAP-20A-08R	3/4	27.2	18	10.39	36	28	11	52.5	PT 1
BAP-25A-10R	1	34.0	23	12.70	46	33	12	59	PT 1-1/4
BAP-32A-12R	1-1/4	42.7	29	12.70	50	36	17	67	PT 1-1/2
BAP-40A-16R	1-1/2	48.6	33	15.88	65	37	20	72	PT 2

BAP-G
Adapter

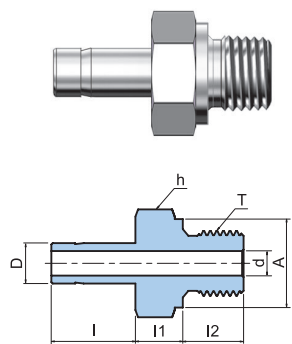

Part No.	Tube OD		Dimension						
	D		d	A	h	I	I1	I2	T
BAP-06-01G	6		3	14	14	20	8	8	PF 1/8
BAP-08-02G	8		5	18	19	20	9	12	PF 1/4
BAP-10-02G	10		6	18	19	21	9	12	PF 1/4
BAP-10-03G	10		6	21.5	22	21	10	12	PF 3/8
BAP-12-02G	12		7	18	19	22	9	12	PF 1/4
BAP-12-03G	12		8	21.5	22	22	10	12	PF 3/8
BAP-15-03G	15		8	21.5	22	24	10	12	PF 3/8
BAP-15-04G	15		10	25.5	27	24	13	14	PF 1/2
BAP-16-04G	16		11	25.5	27	24	13	14	PF 1/2
BAP-18-04G	18		12	25.5	27	24	13	14	PF 1/2
BAP-20-06G	20		14	31.5	32	25	16	16	PF 3/4
BAP-22-06G	22		14	31.5	32	26	16	16	PF 3/4
BAP-25-06G	25		16	31.5	32	28	16	16	PF 3/4
BAP-25-08G	25		17	38	41	28	18	18	PF 1
BAP-28-08G	28		18	38	41	28	18	18	PF 1
BAP-30-08G	30		20	38	41	29	21	18	PF 1
BAP-30-10G	30		20	48.5	50	29	21	20	PF 1-1/4
BAP-32-10G	32		22	48.5	50	30	21	20	PF 1-1/4
BAP-38-12G	38		26	53.5	55	36	21	21	PF 1-1/2
BAP-40-12G	40		28	53.5	55	36	21	21	PF 1-1/2
BAP-50-16G	50		34	66	70	37	28	24	PF 2
BAP-6A-02G	1/8	10.5	6	18	19	21	9	12	PF 1/4
BAP-8A-03G	1/4	13.8	9	21.5	22	22	10	12	PF 3/8
BAP-10A-04G	3/8	17.3	11	25.5	27	24	13	14	PF 1/2
BAP-15A-06G	1/2	21.7	14	31.5	32	26	16	16	PF 3/4
BAP-20A-08G	3/4	27.2	18	38	41	28	18	18	PF 1
BAP-25A-10G	1	34.0	23	48.5	50	33	21	20	PF 1-1/4
BAP-32A-12G	1-1/4	42.7	29	53.5	55	36	23	21	PF 1-1/2
BAP-40A-16G	1-1/2	48.6	33	66	70	37	28	24	PF 2

- Dimensions and Drawings are for reference only and are subject to change without prior notice.
- Unless otherwise specified, all dimensions are in millimeters.
- Sizes, pressure classes, and end connections not listed are available upon request.
- Length given approximate figure with tightened nut.

BRD

Reducer

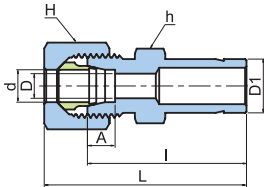
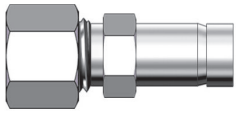

Part No.	Tube OD		Dimension							
	D	D1	d	A	H	h	I	L		
BRD-06-08	6	8	4	7	14	14	39	49.5		
BRD-06-10	6	10	4	7	14	14	40	50.5		
BRD-08-10	8	10	6	7	17	17	40	50.5		
BRD-06-12	6	12	4	7	14	14	41	51.5		
BRD-08-12	8	12	6	7	17	17	41	51.5		
BRD-10-12	10	12	8	7	19	17	41	52.5		
BRD-08-15	8	15	6	7	17	17	43	53.5		
BRD-10-15	10	15	8	7	19	17	43	54.5		
BRD-06-16	6	16	4	7	14	17	43	53.5		
BRD-10-16	10	16	8	7	19	17	43	54.5		
BRD-12-16	12	16	10	7	22	19	43	54.5		
BRD-10-18	10	18	8	7	19	19	44	55.5		
BRD-15-18	15	18	12	7.5	27	24	45	57.5		
BRD-06-20	6	20	4	7	14	22	45	55.5		
BRD-12-20	12	20	10	7	22	22	45	56.5		
BRD-16-20	16	20	13	7.5	30	27	47	59.5		
BRD-15-22	15	22	12	7.5	27	24	48	60.5		
BRD-18-22	18	22	14	8	32	27	48	60.5		
BRD-16-25	16	25	13	7.5	30	27	50	62.5		
BRD-20-25	20	25	17	8	36	30	52	64.5		
BRD-18-28	18	28	14	8	32	30	52	64.5		
BRD-22-28	22	28	18	9	36	32	52	64.5		
BRD-20-30	20	30	17	8	36	32	53	65.5		
BRD-25-30	25	30	20	10	41	36	54	67.5		
BRD-25-32	25	32	20	10	41	36	55	68.5		
BRD-22-35	22	35	18	9	36	36	58	70.5		
BRD-28-35	28	35	22	10	46	41	60	74		
BRD-25-28	25	38	20	10	41	41	61	74.5		
BRD-30-38	30	38	25	10	46	41	63	77.5		
BRD-6A-8A	1/8	10.5	1/4	13.8	8	7	19	17	41	52.5
BRD-6A-10A	1/8	10.5	3/8	17.3	8	7	19	19	44	55.5
BRD-8A-10A	1/4	13.8	3/8	17.3	11	7.5	24	22	46	58
BRD-8A-15A	1/4	13.8	1/2	21.7	11	7.5	24	24	48	60
BRD-10A-15A	3/8	17.3	1/2	21.7	14	8	32	27	48	60.5
BRD-10A-20A	3/8	17.3	3/4	27.2	14	8	32	30	52	64.5
BRD-15A-20A	1/2	21.7	3/4	27.2	18	9	36	32	52	64.5
BRD-20A-25A	1/2	21.7	1	34.0	18	9	36	36	58	70.5
BRD-25A-32A	3/4	27.2	1	34.0	22	10	46	41	60	74

BAE

Adjustable Elbow

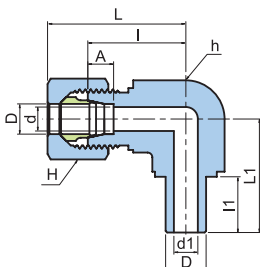
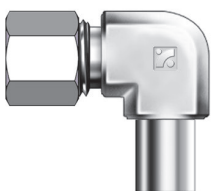

Part No.	Tube OD D	Dimension								
		d	d1	A	H	h	I	I1	L	L1
BAE-10	10	8	6	7	19	17	23	21	34.5	35
BAE-12	12	10	8	7	22	19	24	22	35.5	37
BAE-15	15	12	10	7.5	27	24	29	24	44.5	40
BAE-16	16	13	11	7.5	30	27	32	24	44.5	43
BAE-18	18	14	12	8	32	27	32	24	44.5	43
BAE-20	20	17	14	8	36	30	33	25	45.5	45
BAE-22	22	18	14	9	36	32	34	26	46.5	46
BAE-25	25	20	17	10	41	36	36	28	49.5	49
BAE-28	28	22	18	10	46	41	41	28	55	53
BAE-30	30	25	20	10	46	41	41	29	55.5	54
BAE-32	32	26	22	11	50	46	50	30	64.5	66
BAE-38	38	32	26	12	60	50	50	36	69.5	72

- Dimensions and Drawings are for reference only and are subject to change without prior notice.
- Unless otherwise specified, all dimensions are in millimeters.
- Sizes, pressure classes, and end connections not listed are available upon request.
- Length given approximate figure with tightened nut.

BABT

Adjustable Branch Tee



Part No.	Tube OD D	Dimension								
		d	d1	A	H	h	I	I1	L	L1
BABT-10	10	8	6	7	19	17	23	21	34.5	35
BABT-12	12	10	8	7	22	19	24	22	35.5	37
BABT-15	15	12	10	7.5	27	24	32	24	44.5	43
BABT-16	16	13	11	7.5	30	27	32	24	44.5	43
BABT-18	18	14	12	8	32	27	32	24	44.5	43
BABT-20	20	17	14	8	36	30	33	25	45.5	45
BABT-22	22	18	14	9	36	32	34	26	46.5	46
BABT-25	25	20	17	10	41	36	36	28	49.5	49

BART

Adjustable Run Tee



Part No.	Tube OD D	Dimension								
		d	d1	A	H	h	I	I1	L	L1
BART-10	10	8	6	7	19	17	23	21	34.5	35
BART-12	12	10	8	7	22	19	24	22	35.5	37
BART-15	15	12	10	7.5	27	24	32	24	44.5	43
BART-16	16	13	11	7.5	30	27	32	24	44.5	43
BART-18	18	14	12	8	32	27	32	24	44.5	43
BART-20	20	17	14	8	36	30	33	25	45.5	45
BART-22	22	18	14	9	36	32	34	26	46.5	46
BART-25	25	20	17	10	41	36	36	28	49.5	49

- Dimensions and Drawings are for reference only and are subject to change without prior notice.
 - Unless otherwise specified, all dimensions are in millimeters.
 - Sizes, pressure classes, and end connections not listed are available upon request.
 - Length given approximate figure with tightened nut.

BAPV

Air Purge Valve (Tube End)

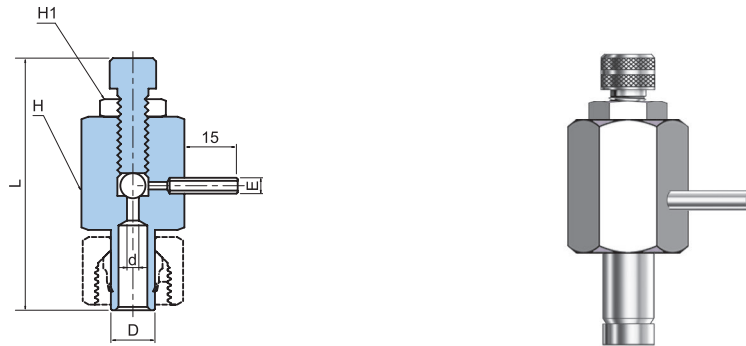

Part No.	Dimension						
	D	E	d	H	H1	L	Ball
BAPV-06	6	4	3	14	13	56	7/32
BAPV-08	8	4	3	14	13	56	7/32
BAPV-10	10	4	3	14	13	57	7/32
BAPV-12	12	4	3	14	13	58	7/32
BAPV-15	15	6	4	27	19	74	5/16
BAPV-16	16	6	4	27	19	74	5/16
BAPV-18	18	6	4	27	19	74	5/16
BAPV-20	20	6	4	27	19	75	5/16
BAPV-22	22	6	4	27	19	76	5/16
BAPV-25	25	6	4	27	19	78	5/16
BAPV-28	28	6	4	30	19	78	5/16
BAPV-6A	10.5	4	3	14	13	57	7/32
BAPV-8A	13.8	6	4	27	19	72	5/16
BAPV-10A	17.3	6	4	27	19	74	5/16
BAPV-15A	21.7	6	4	27	19	76	5/16
BAPV-20A	27.2	6	4	30	19	79	5/16

BAPV-R

Air Purge Valve (Thread End)

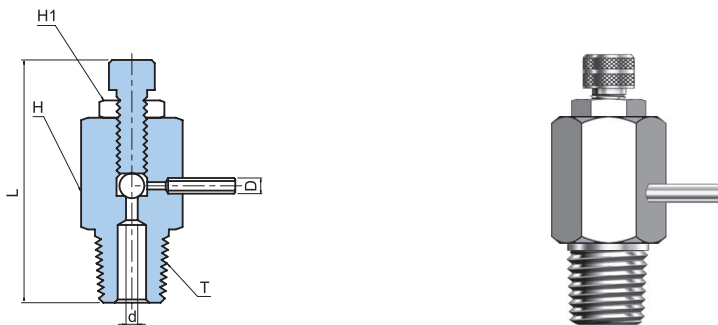

Part No.	Dimension						
	D	d	H	H1	L	Ball	T
BAPV-01R	4	3	14	13	51	7/32	PT 1/8
BAPV-02R	4	3	14	13	53	7/32	PT 1/4
BAPV-03R	6	4	19	13	54	7/32	PT 3/8
BAPV-04R	6	4	27	19	69	5/16	PT 1/2

- Dimensions and Drawings are for reference only and are subject to change without prior notice.
- Unless otherwise specified, all dimensions are in millimeters.
- Sizes, pressure classes, and end connections not listed are available upon request.
- Length given approximate figure with tightened nut.

Copper Gasket

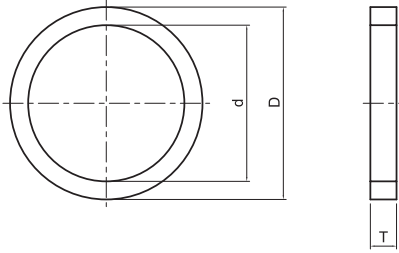

Bonded Seal

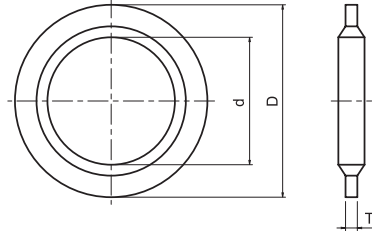

Part No.	Male Thread	Dimension		
		d	D	T
BCG-01	PF 1/8	10	18	2
BCG-02	PF 1/4	14	22	2
BCG-03	PF 3/8	17	26	2
BCG-04	PF 1/2	22	32	2
BCG-06	PF 3/4	27	38	2
BCG-08	PF 1	34	42	2
BCG-10	PF 1-1/4	43	53	2
BCG-12	PF 1-1/2	49	60	2
BCG-16	PF 2	61	72	2

Part No.	Male Thread	Dimension		
		d	D	T
BBS-01	PF 1/8	9.9	17	2
BBS-02	PF 1/4	13.3	20.5	2
BBS-03	PF 3/8	16.8	24	2
BBS-04	PF 1/2	21.1	29	2
BBS-06	PF 3/4	26.6	34.5	2
BBS-08	PF 1	33.4	41.5	2.3
BBS-10	PF 1-1/4	42.1	50.5	2.3
BBS-12	PF 1-1/2	48.0	57	2.3
BBS-16	PF 2	59.8	69	2.3

Male Stud Form and Sealing

Male stud form A sealing by o-ring and bonded seal

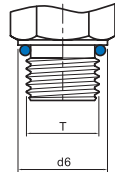

Male stud form B sealing by copper gasket.

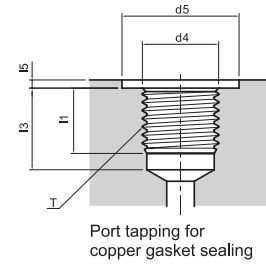
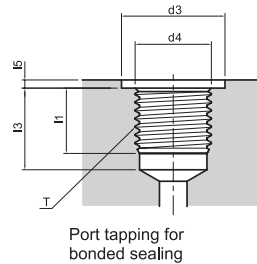
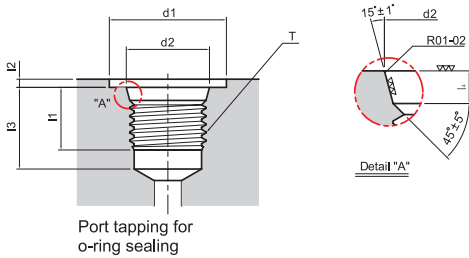
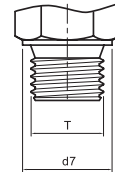

T	d1	d2 ^{+0.1}	d3 ^{+0.3}	Max d4	d5 ^{+0.3}	d6	d7	Min l1	Max l2	Min l3	l4 ^{+0.4}	l5	Suitable Seal		
													O-Ring	Bonded Seal	Copper Gasket
PF 1/8	18	11.6	17.4	9.7	18.2	14	14	10	1.0	15	2.0	1	P 8	BBS-01	BCG-01
PF 1/4	24	15.6	20.9	13.1	22.2	19	18	14	1.5	20	2.5	1	P 11	BBS-02	BCG-02
PF 3/8	28	18.6	24.4	16.6	26.2	22	21.5	14	2.0	20	2.5	1	P 14	BBS-03	BCG-03
PF 1/2	34	22.6	29.4	20.9	32.2	27	25.5	17	2.5	25	2.5	1	P 18	BBS-04	BCG-04
PF 3/4	45	29.8	34.9	26.4	38.2	36	31.5	19	2.5	27	3.5	1	P 24	BBS-06	BCG-06
PF 1	51	35.8	41.9	33.2	42.3	41	38	22	2.5	31	3.5	1	P 29	BBS-08	BCG-08
PF 1-1/4	62	44.8	50.9	41.9	53.3	50	48.5	24	2.5	33	3.5	1	P 38	BBS-10	BCG-10
PF 1-1/2	68	50.8	57.4	47.8	60.3	55	53.5	25	2.5	34	3.5	1	P 44	BBS-12	BCG-12
PF 2	76	67.2	69.4	59.6	72.3	75	66	29	2.5	38	3.5	1	P 56	BBS-16	BCG-16

- Dimensions and Drawings are for reference only and are subject to change without prior notice.
- Unless otherwise specified, all dimensions are in millimeters.
- Sizes, pressure classes, and end connections not listed are available upon request.
- Length given approximate figure with tightened nut.

BMT Co., Ltd.

Headquarters

(46031) 부산시 기장군 장안읍 신소재산단2로 17 (반룡리)

17, Sinsojaesandan 2-ro, Jangan-eup, Gijang-gun, Busan, 46031 South Korea

TEL: +82 51 780 5000 FAX: +82 51 780 5100

E-mail: superlok@superlok.com

WEB: www.superlok.com

Fittings & Valves

Industrial

Instrumentation Tube Fittings

i-Fitting®

Ball/Plug Valves

Double Block & Bleed Valves

Manifold/Gauge Valves

Globe/Needle Valves

Cryogenic Valves

Check/Relief/Excess Flow Valves

Medium/High Pressure Fittings & Valves

Eco-fuel Conversion and Supply Units

Ultra High Purity

HGB® (High-integrated Gas Box)

HGS® (High-integrated Gas System)

Weld & Metal Face Seal Fittings

Bend Fittings

Diaphragm Valves

Bellows Valves

Check Valves

Clean Ball Valves

Regulators

Gas Filters

HGB® : Trademark registered in Republic of Korea, Japan and United States (as of August 2025)

HGS® : Trademark registered in Republic of Korea, Japan and United States (as of May 2025)

Electric & Energy

Metal Clad Switchgear (MCSG)

Compact Switchboard

Motor Control Center (MCC)

Smart Distribution Board

Energy Management System (EMS)